

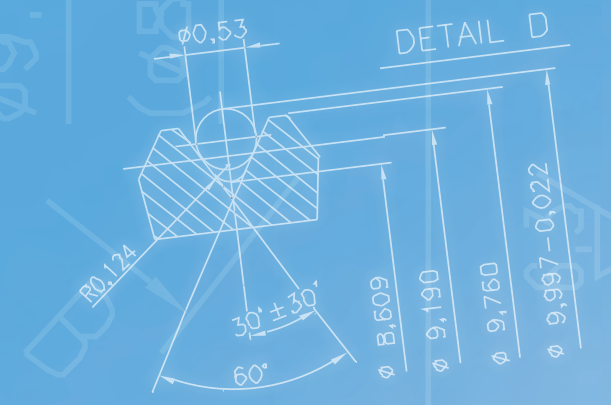

EUROPEAN UNION
EUROPEAN REGIONAL DEVELOPMENT FUND
INVESTMENT IN YOUR FUTURE



NAREX Žďánice, spol. s r.o.
Městečko 250
696 32 Žďánice
Czech Republic
tel.: ++420 518 607 111
fax: ++420 518 607 155
e-mail: sales@narexzd.cz
http: www.narexzd.cz



Doporučené použití závitníků <i>Selection charts for taps / Anwendungsübersicht Gewindebohrer</i>	1 – 4
Skupiny obráběných materiálů <i>Material groups / Werkstoffgruppe</i>	5 – 6
Zkratky, symboly <i>Used symbols / Symbole</i>	7
Postup při výběru závitníků <i>How to find the best type of tap / Leitfaden optimale Gewindebohrer</i>	8
Volba závitníku podle obráběného materiálu <i>Tap selection according to material groups / Gewindebohrerwahl nach Werkstoffgruppe</i>	9 – 29
Strojní závitníky <i>Machine taps / Maschinengewindebohrer</i>	30 – 66
Strojní krátké závitníky <i>Short machine taps / Kurze Maschinengewindebohrer</i>	67
Tváreční závitníky <i>Forming taps / Formgewindebohrer</i>	68
Maticové závitníky <i>Nut taps / Muttergewindebohrer</i>	69
Ruční sadové závitníky <i>Hand taps / Handgewindebohrer</i>	70 – 76
Ostatní závitníky <i>Other taps / Sonstige Gewindebohrer</i>	77 – 78
Soupravy závitorezných nástrojů <i>Threading tool sets / Gewindewerkzeugsätze</i>	79 – 81
Závitové kruhové čelisti <i>Circular screwing dies / Schneideisen</i>	82 – 87
Technické informace <i>Technical information / Technische Informationen</i>	88 - 120

		800 N/mm ²		1 100 N/mm ²		UNI		1 400 N/mm ²		INOX		AL		GG		
●	Doporučené užití / Recommended use / Optimal															
●	Možno použít / Possible use / Geeignet															
Řezný kužel / Chamfer / Anschnitt		C 2 - 3		B 3,5 - 6		D 3,5 - 5		E 1,5								
Katalogové číslo / Cat. No. / Kat. Nr.																
Strana katalogu Catalogue page No. Siehe Katalog Seite		M	X=0	MF	X=0	G	X=2	UNC	X=4	UNF	X=5					
Řezný kužel / Chamfer / Anschnitt		C	C	C	C	B	B	B	B	B	B	C	C	C	C	
Druh otvoru / Hole type / Lochart																
1	Měkké konstrukční oceli s pevností do 500 N/mm ² / Soft structural steels up to 500 N/mm ² / Weiche Baustähle bis 500 N/mm ²	1.1.	Konstrukční oceli / Structural steels / Baustähle	●	●	●	●	●	●	●	●	●	●	●	●	
		1.2.	Nelegované lité oceli / Plain cast steels / Unlegierte Gussstähle					●	●	●	●					
2	Automatové a konstrukční oceli s pevností do 800 N/mm ² / Free cutting steels and structural steels up to 800 N/mm ² / Automatenstähle und Baustähle bis 800 N/mm ²	2.1.	Automatové oceli / Free cutting steels / Automatenstähle	●	●	●	●	●	●	●	●					
		2.2.	Konstrukční a zušlechtné oceli / Structural steels and heat-treated steels / Baustähle und Vergütungsstähle					●	●	●	●	●	●	●	●	●
		2.3.	Nelegované lité oceli / Plain cast steels / Unlegierte Gussstähle					●	●	●	●	●	●	●	●	●
3	Zušlechtné a nástrojové oceli s pevností do 1100 N/mm ² / Heat-treated steels and tool steels up to 1100 N/mm ² / Vergütungsstähle und Werkzeugstähle bis 1100 N/mm ²	3.1.	Cementační a nitridační oceli / Case hardened steels and nitriding steels / Einsatzstähle und Nitrierstähle													
		3.2.	Zušlechtné oceli / Heat-treated steels / Vergütungsstähle													
		3.3.	Nástrojové oceli / Tool steels / Werkzeugstähle													
4	Vysoc legované a zušlechtné oceli s pevností do 1400 N/mm ² / High-alloyed steels and heat-treated steels up to 1400 N/mm ² / Hochlegiertestähle und Vergütungsstähle bis 1400 N/mm ²	4.1.	Vysoc legované oceli / High-alloyed steels / Hochlegiertestähle													
		4.2.	Zušlechtné oceli / Heat-treated steels / Vergütungsstähle													
5	Nerezavějící a žáruvzdorné oceli / Stainless steels and heat resisting steels / Rostfreistähle und Hitzebeständigstähle	5.1.	S pevností 450 - 800 N/mm ² / With strength 450 - 800 N/mm ² / Mit Festigkeit bis 450 - 800 N/mm ²													
		5.2.	S pevností 600 - 1000 N/mm ² / With strength 600 - 1000 N/mm ² / Mit Festigkeit bis 600 - 1000 N/mm ²													
6	Litiny / Cast iron / Gusswerkstoffe	6.1.	Šedá litina / Grey cast iron / Grauguss	●	●	●	●									
		6.2.	Tvárná a temperovaná litina / Spheroidal graphite cast iron and malleable cast iron / Sphäroguss und Temperguss					●	●			●	●	●	●	●
7	Hliník měkký / Unalloyed aluminium / Reinaluminium	7.1.	Čistý hliník / Unalloyed aluminium / Reinaluminium													
8	Hliník legovaný / Aluminium alloys / Aluminiumlegierungen	8.1.	S obsahem Si < 10% / Si content < 10% / Si-Gehalt < 10%					●	●	●	●	●	●	●	●	
		8.2.	S obsahem Si > 10% / Si content > 10% / Si-Gehalt > 10%	●	●	●	●	●	●	●	●	●	●	●	●	●
9	Měď čistá / Unalloyed copper / Reinkupfer	9.1.	Měď čistá bez přísad / Unalloyed copper / Reinkupfer													
10	Slitiny mědi / Copper alloys / Kupferlegierungen	10.1.	Krátká drobná tříška / Short chipping / Kurzspanend	●	●	●	●	●	●	●	●	●	●	●	●	
		10.2.	Dlouhá vinutá tříška / Long chipping / Langspanend									●	●	●	●	●
11	Zinek / Zinc / Zink	11.1.	Zinek a slitiny zinku / Zinc and zinc alloys / Zink und Zinklegierungen									●			●	

STROJNÍ ZÁVITNÍKY
MACHINE TAPS
MASCHINENGEWINDEBOHRER

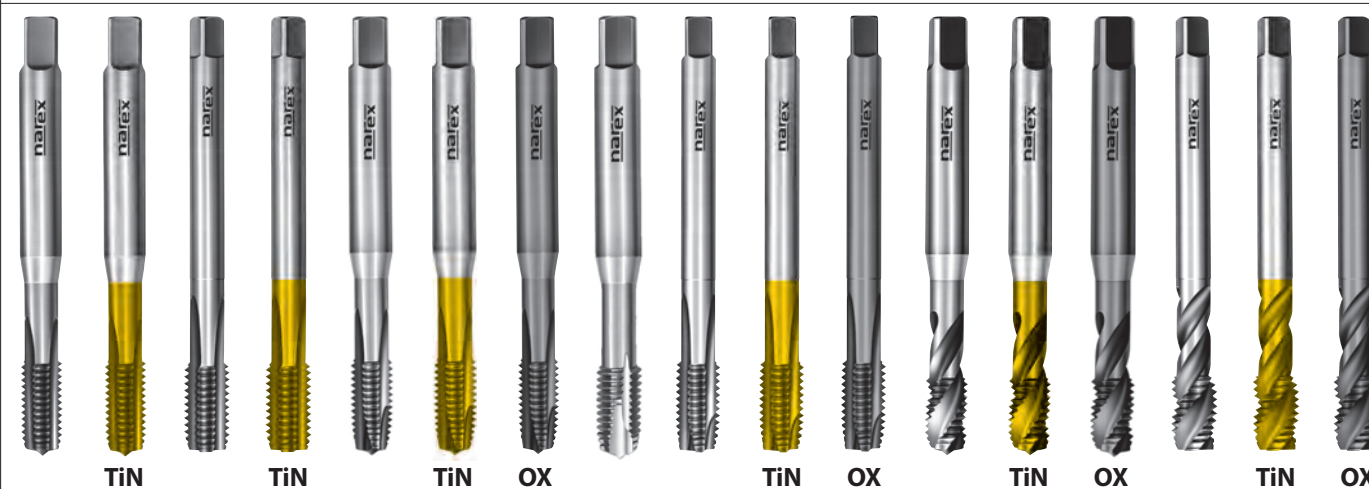

TiN TiN TiN OX TiN OX TiN OX TiN OX

	100X	101X	300X	301X	150X	151X	154X	175X	350X	351X	354X	205X	206X	209X	405X	406X	409X
	30	30	31	31	32	32	32	32	33	33	33	34	34	34	35	35	35
			49	49					49	49	49				51	51	51
	62	62	63	63	62	62			63	63		64	64		64	64	
			65	65					65	65					66	66	
	C	C	C	C	B	B	B	B	B	B	B	C	C	C	C	C	C

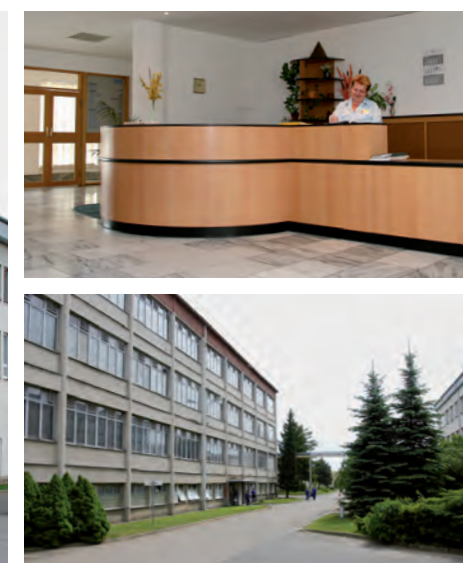

NAREX Žďánice, spol. s r. o. se svou 80 letou tradicí je specializována zejména na výrobu závitníků z výkonných a vysoce výkonných rychlořezných ocelí a je dnes jejich největším výrobcem v České republice a jedním z největších výrobců ve střední Evropě. Standardní výrobní sortiment obsahuje závitníky strojní, závitníky tvářecí, závitníky maticové a závitníky sadové, soupravy závitovězých nástrojů a závitové kruhové čelisti. Nejen tradice, ale především moderní výrobní technologie s využitím nejmodernějších CNC strojů, práce kvalifikovaných odborníků a v roce 1997 zavedený certifikovaný systém managementu jakosti v oboru „Vývoj a výroba závitovězých nástrojů, tepelné zpracování kovů“ podle evropské normy EN ISO 9001:2008 jsou zárukou vysoké a stabilní kvality našich výrobků. Vedle standardního výrobního sortimentu vyrábíme na zakázku podle požadavků zákazníků také speciální závitovězné nástroje a závitové kalibr. V kooperaci pak provádíme tepelné zpracování - kalení, popouštění, cementování všech ocelí na nejmodernějších zařízeních a dále popisování výrobků laserem. Pracovníci NAREX Žďánice, spol. s r. o. Vám rádi poskytnou technické poradenství při používání závitovězých nástrojů, technické poradenství při zavádění nových výrob se závitovacími

operacemi, technické poradenství při stavbě jed noučelových strojů s použitím závitovězých nástrojů a konzultace při potížích s řezáním závitů. Naším hlavním cílem je zachování Vaší příz nů a posílení důvěry ve značku výrobků NAREX. Company NAREX Žďánice, spol. s r. o. with 80 years old tradition, is specialized on production of taps of high-speed steels and extra high-speed steels. We have long-term experience in production of tread cutting tools and today we are the biggest producer in Czech Republic and one of the largest producers in middle Europe. Between standard assortment produced here are included: machine taps for full variety of different materials, forming taps, nut taps, hand taps and dies. Our qualified employees, the state-of-the-art production facilities and a company-wide quality assurance system by EN ISO 9001:2008 guarantee the consistently high quality standard of our products and services. Beside the standard production programme we also produce special thread-cutting tools. Our major aim is to keep Your favour and strengthen Your trust into mark of NAREX products.

NAREX Žďánice, spol. s r. o. blickt auf eine 80-jährige Firmengeschichte zurück. Seit 1938 hat sich unser Unternehmen auf die Herstellung von leistungsfähigen Gewindebohrern aus Hochleistungs-Schnellschneidstählen spezialisiert. In der Tschechischen Republik ist NAREX der größte Hersteller von dieser Werkzeugen und einer der Führenden in Mitteleuropa. Unser Standardprogramm beinhaltet Maschinen-gewindebohrer, Gewindeformer, Muttergewinde-bohrer, Handgewindebohrer, Sätze von Gewinde-schneidwerkzeugen, sowie Schneideisen. Neben unserer Erfahrung in der Herstellung von Präzisionwerkzeugen garantieren unser moder-ner Maschinenpark und unsere hochqualifizier-ten Mitarbeiter eine gleichbleibende Qualität der NAREX-Produkte auf sehr hohem Niveau. Im Jahre 1997 wurde NAREX Žďánice, spol s r. o. nach EN ISO 9001:2008 zertifiziert. Die Zertifizie-rung beinhaltet alle Bereiche der Entwicklung, der Wärmebehandlung der Stähle und der Fertigung. Neben unserem Standardprogramm fertigen wir auch Gewinde-Sonderwerkzeuge nach den Vor-gaben unsere Kunden. Unser Hauptziel ist Ihre Zufriedenheit mit unseren Produkten und unserem Service, als Grundlage ei-ner vertrauensvollen Zusammenarbeit zwischen NAREX und Ihrem Unternehmen.



STROJNÍ ZÁVITNÍKY
MACHINE TAPS
MASCHINENGWINDEBOHRER

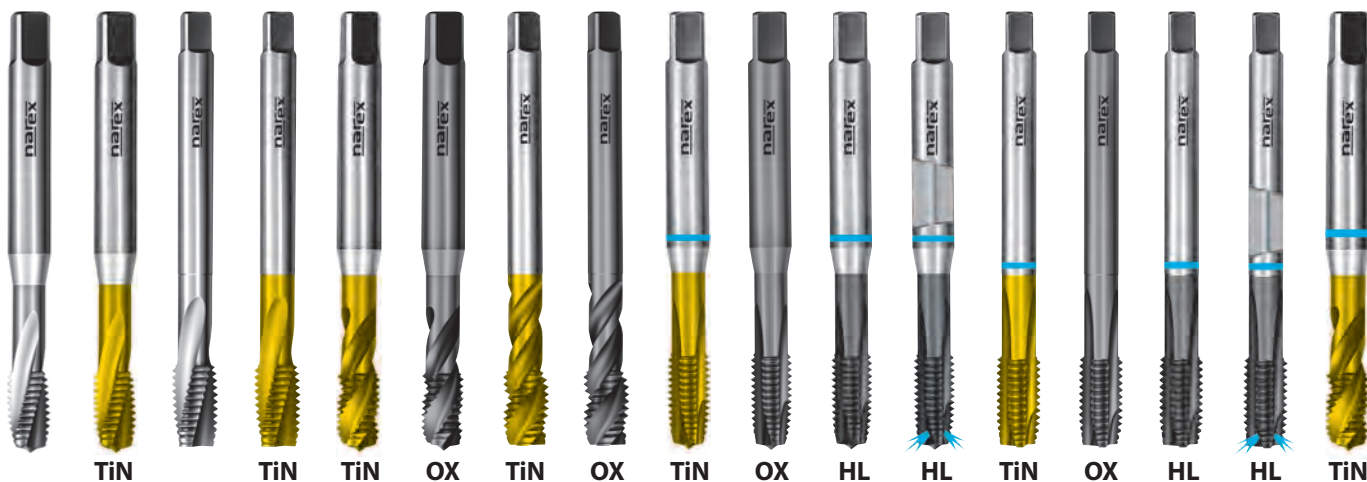

	240X	241X	440X	441X	236X	239X	436X	439X	166X	169X	187X	187X IKZN	366X	369X	387X	387X IKZN	226X
	36	36	37	37	36	36	37	37	38	38	38	38	39	39	39	39	40
													53	53			
													61	61			
	C	C	C	C	C	C	C	C	B	B	B	B	B	B	B	B	C
					●	●	●	●									
					●	●	●	●									
					●	●	●	●									
	●	●	●	●	●	●	●	●									
									●	●	●	●	●	●	●	●	●
											●	●			●	●	●
		●		●													●
					●	●	●	●									
					●		●		●		●	●	●		●	●	●
	●	●	●	●					●		●	●	●		●	●	●
									●		●	●	●		●	●	●

STROJNÍ ZÁVITNÍKY
MACHINE TAPS
MASCHINENGWINDEBOHRER



	OX	HL	HL	TiN	OX	HL	HL	TiCN	OX	TiCN	OX	TiCN	OX	TiCN	OX	FNT	FNT	FNT	FNT
	229X	232X	232X IKZ	426X	429X	432X	432X IKZ	158X	159X	358X	359X	268X	269X	468X	469X	192X	392X	282X	287X
	40	40	40	41 53 61	41	41	41	42	42	43 55	43 55	42	42	43 55	43 55	44	44	44	44
	C	C	C	C	C	C	C	B	B	B	B	C	C	C	C	B	B	D	C
	●	●	●	●	●	●	●	●		●		●		●					
		●	●	● _G		●	●	●	●	●	●	●	●	●	●				
		●	●	●		●	●	●		●	●			●					
																●	●	●	●
	●	●	●	●	●	●	●												
	●	●	●	●	●	●	●												
				●				●		●		●		●					
									●	● _{MF}	●			● _{MF}					
		●	●	●		●	●												
		●	●	●		●	●												

STROJNÍ ZÁVITNÍKY MACHINE TAPS MASCHINENGWINDEBOHRER			STROJNÍ KRÁTKÉ ZÁVITNÍKY SHORT MACHINE TAPS KURZE MASCHINENGWINDEBOHRER			TVÁŘECÍ ZÁVITNÍKY FORMING TAPS FORMGWINDEBOHRER		MATICOVÉ ZÁVITNÍKY NUT TAPS MUTTERGWINDEBOHRER	RUČNÍ SADOVÉ ZÁVITNÍKY HAND TAPS HANDGWINDEBOHRER		
TiN	TiN	TiN				TiN	TiN				OX
371X	221X	421X	055X	060X	065X	291X	296X	500X	020X	030X	029X
48	48	48	67	67	67	68	68	69	70	72	71
										74	
										75	
										76	
B	C	C	B	C	C	C	C		C	C	C
			●			●	●	●	●	●	
			●				●	●	●	●	
●	●	●	●			●	●	●	●	●	
●	●	●	●	●				●	●	●	
●	●	●	●	●							
●	●	●									
●	●	●									●
●	●	●									●
●	●	●							●	●	●
●	●	●	●	●		●	●		●	●	●
●	●	●	●					●	●	●	
●	●	●					●				
●	●	●			●		●				
●	●	●	●	●				●	●	●	
●	●	●						●	●	●	
●	●	●						●			
			●		●			●	●	●	
●	●	●		●				●			
						●					







ČSN (Czech)	Wr.Nr.	DIN (Germany)	AISS (U.S.A.)	AFNOR (France)	Strana
1 - Měkké konstrukční oceli s pevností do 500 N/mm² / Soft structural steels up to 500 N/mm² / Weiche Baustähle bis 500 N/mm²					9
1.1 Konstrukční oceli / Structural steels / Baustähle					
10004	1.0035	St 33		A33	
11320	1.0320	St 22		Fd1, Fd2	
11364	1.0345	H I			
11373	1.0037	St 37-2	A 283 Gr.C	E 24-2	
11378	1.0116	St 37-3	A 284 Gr.D	E 24-3	
11474	1.0445	H IV			
1.2 Nelegované lité oceli / Plain cast steels / Unlegierte Gussstähle					
422630	1.0416	GS 38			
2 - Automatové a konstrukční oceli s pevností do 800 N/mm² / Free cutting steels and structural steels up to 800 N/mm² / Automatenstähle und Baustähle bis 800 N/mm²					11
2.1 Automatové oceli / Free cutting steels / Automatenstähle					
11109	1.0715	9SMn28	1213	S 250	
11110	1.0721	10S20	1108, 1109	10 F1	
2.2 Konstrukční a zušlechťené oceli / Structural steels and heat-treated steels / Baustähle und Vergütungsstähle					
11500	1.0050	St 50-2	A 570 Gr.50	A 5D-2	
11523	1.0570	St 52-3	A 714 Gr.III	E 36-3	
11600	1.0060	St 60-2	A 572 Gr.65	A 60-2	
11700	1.0070	St 70-2		A 70-2	
12010	1.0305	C 10	1010		
12040	1.0501	C 35	1035	1 C 35	
12050	1.0503	C 45	1045	1 C 45	
12060	1.0535	C 55	1055	1 C 55	
2.3 Nelegované lité oceli / Plain cast steels / Unlegierte Gussstähle					
422640	1.0443	GS 45			
422660	1.0558	GS 60			
3 - Zušlechťené a nástrojové oceli s pevností do 1100 N/mm² / Heat-treated steels and tool steels up to 1100 N/mm² / Vergütungsstähle und Werkzeugstähle bis 1100 N/mm²					14
3.1 Cementační a nitridační oceli / Case hardened steels and nitriding steels / Einsatzstähle und Nitrierstähle					
14220	1.7131	16MnCr5	5115	16 MC 4	
16420	1.5752	14NiCr14	A 646 Gr.1	13 NiCr14	
3.2 Zušlechťené oceli / Heat-treated steels / Vergütungsstähle					
15142	1.7225	42CrMo4	4140, 4142	42 CD 4	
15260	1.8159	50CrV4	A 646 Gr.14	50 CD 4	
19552	1.2343	X38CrMoV5-1	H 11	Z 38 CDV 5	
19720	1.2567	X30WCrV5-3		Z 32 WCV 5	
19751	1.2622	X60WCrMoV9-4			
3.3 Nástrojové oceli v přírodním stavu / Tool steels / Werkzeugstähle					
19312	1.2842	90MnCrV8	2	90 MV 8	
19436	1.2080	X210Cr12	D3	Z 200 C 12	
19552	1.2343	X38CrMoV5-1	H 11	Z 38 CDV 5	
19751	1.2622	X60WCrMoV9-4			
19830	1.3343	S6-5-2	M 2	Z85WDCV	
19852	1.3243	S6-5-2-5	M 35	Z85WDKCV	
4 - Vysoce legované a zušlechťené oceli s pevností do 1400 N/mm² / High-alloyed steels and heat-treated steels up to 1400 N/mm² / Hochlegiertestähle und Vergütungsstähle bis 1400 N/mm²					16
4.1 Vysoce legované oceli / High-alloyed steels / Hochlegiertestähle					
15330	1.7707	30CrMoV9	G43406	30CrMoV9	
Inconel 718	2.4668	NiCr19Fe19Nb5Mo3	Unitemp 718		
HARDOX 400					
4.2 Zušlechťené oceli po tepelném zpracování / Heat-treated steels / Vergütungsstähle					
15142	1.7225	42CrMo4	4140, 4142	42 CD 4	
15260	1.8159	50CrV4	A 646 Gr.14	50 CD 4	
16523	1.5860	4NiCr18			
19452	1.2101	62SiMnCr4			
19552	1.2343	X38CrMoV5-1	H 11	Z 38 CDV 5	
19573	1.2379	X155CrVMo12-1	A 681 Type D2		
5 - Nerezavějící a žáruvzdorné oceli / Stainless steels and heat resisting steels / Rostfreistähle und Hitzebeständigstähle					17
5.1 S pevností 450 - 800 N/mm ² / With strength 450 - 800 N/mm ² / Mit Festigkeit bis 450 - 800 N/mm ²					
17022	1.4021	X20Cr13	420	Z 20 C 13	
17040	1.4016	X6Cr17	430	Z 8 C 17	
17240	1.4301	X5CrNi18-10	304	Z 6 CN 18.09	
17241	1.4310	X10CrNi18-8	304 LN	Z 3 C 18.07Az	
17246	1.4878	X10CrNiTi18-10	A 479 Type 312 H	Z 6 CNT 18-12 B	
17350	1.4435	X2CrNiMo18-14-3	316 L	Z 3 CND 17.12.03	
17347	1.4571	X6CrNiMoTi17-12-2	A368 Type 316 Ti	Z 6 CNDT 17-12	
422905	1.4006	X12Cr13	410	Z 10 C 13	

ČSN	Wr.Nr.	DIN (Germany)	AISI (U.S.A.)	AFNOR (France)	Strana
5.2 S pevností 600 - 1000 N/mm ² / With strength 600 - 1000 N/mm ² / Mit Festigkeit bis 600 - 1000 N/mm ²					
17241	1.4310	X10CrNi18-8	304 LN	Z 3 C 18.07Az	
17359	1.4406	X2CrNiMo17-11-2	316 LN	Z 3 CND 17.11.02	
17360	1.4429	X2CrNiMoN17-13-3	A 312 Gr.TP 316	Z 3 CND 17.12 Az	
17381	1.4462	X2CrNiMoN22-5-3	A 890 Gr.4 A	Z 3 CND 25-05 Az	
6 - Litiny / Cast iron / Gusswerkstoffe					18
6.1 Šedá litina / Grey cast iron / Grauguss					
422410	0.6010	GG 10	A 48-20 B	Ft 10 D	
422415	0.6015	GG 15	A 48-25 B	Ft 20 D	
422420	0.6020	GG 25	A 48-30 B	Ft 25 D	
422425	0.6025	GG 25	A 48-40 B	Ft 30 D	
422430	0.6030	GG 30	A 48-45 B	Ft 30 D	
422435	0.6035	GG 35	A 48-50 B	Ft 35 D	
6.2 Tvárná a temperovaná litina / Spheroidal graphite cast iron and malleable cast iron / Sphäroguss und Temperguss					
422304	0.7040	GGG 40	60-40-18	FGS 400.12	
422305	0.7050	GGG 50	65-45-12	FGS 500.7	
422306	0.7060	GGG 60	80-55-06	FGS 600.3	
422540	0.8040	GTW 40			
422545	0.8145	GTS 45			
422555	0.8155	GTS 55			
7 - Hliník / Unalloyed aluminium / Reinaluminium					21
7.1 Čistý hliník bez přísad / Unalloyed aluminium / Reinaluminium					
424002	3.0255	Al99,5			
424003	3.0275	Al99,7			
424005	3.0285	Al99,8			
424412	3.3315	AlMg1	5005 A	A-G0,6	
424413	3.3535	AlMg3	5754		
424432	3.0515	AlMn1	3103	A-G3M	
8 - Hliník legovaný / Aluminium alloys / Aluminiumlegierungen					22
8.1 S obsahem Si < 10% / Si content < 10% / Si-Gehalt < 10%					
424332	3.2371	G-AlSi7Mg		A7-S10G	
424338	3.2162	GD-AlSi8Cu3			
424381	3.2134	G-AlSi5Cu1Mg	355.1	A-S4 GV	
8.2 S obsahem Si > 10% / Si content > 10% / Si-Gehalt > 10%					
424331	3.2211	G-AlSi11			
424336	3.2581	G-AlSi12	A 413	A-513	
424384	3.2381	G-AlSi10Mg	A 360	A-S10G	
9 - Měď čistá / Unalloyed copper / Reinkupfer					25
9.1 Měď čistá bez přísad / Unalloyed copper / Reinkupfer					
423003	2.0080	Cu99,85		Cu-FRTP	
423005	2.0120	Cu99,5		C-Cu	
423007	2.1203	CuAg0,1		CuAg 0.10	
10 - Slitiny mědi / Copper alloys / Kupferlegierungen					26
10.1 Krátká drobná tříška / Short chipping / Kurzspanend					
423220	2.0360	CuZn40	C 28000	CuZn 40	
423222	2.0380	CuZn39Pb1	C 28000	CuZn 40	
423223	2.0410	CuZn40Pb2			
10.2 Dlouhá vinutá tříška / Long chipping / Langspanend					
423203	2.0250	CuZn40	C 24000	CuZn 20	
423210	2.0265	CuZn30	C 26000	CuZn 30	
423213	2.0321	CuZn37	C 27400	CuZn 37	
11 - Zinek / Zinc / Zink					29
11.1 Zinek a slitiny zinku / Zinc and zinc alloys / Zink und Zinklegierungen					
423560	2.2143	ZnAl4Cu1			
423562	2.2144	ZnAlCu3			

ZKRATKY A SYMBOLY

Used symbols / Symbole

d_1	- rozměr závitu / thread size / Gewindeabmessung
P	- stoupání závitu / pitch of the thread / Steigung
N	- stoupání závitu v počtu závitů na 1" / pitch of the thread in threads per inch / Steigung in Gangzahl / 1"
LH	- levý závit / left-hand thread / Linksgewinde
HSS	- výkonná rychlořezná ocel / high speed steel / Schnellarbeitsstahl
HSSE	- vysoce výkonná rychlořezná ocel / super high speed steel / höher legierter Schnellstahl
HSSE PM	- prášková rychlořezná ocel / powder high speed steel / Pulverstahl
HSSE V3	- vysoce výkonná rychlořezná ocel legovaná vanadem / super high speed steel 3% vanadium alloyed / höher legierter Schnellstahl V 3%
TiN	- povlak nitrid titanu / titanium nitride coating / Titanitrid-Beschichtung
TiCN	- povlak karbonitrid titanu / titanium carbonitride coating / Titancarbonitrid-Beschichtung
TiAlN	- povlak aluminiumnitrid titanu / titanium aluminiumnitride coating / Titanaluminiumnitrid-Beschichtung
FNT	- povlak Balinit® Futura Nano Top / Balinit® Futura Nano Top coating / Balinit® Futura Nano Top- Beschichtung
HL	- povlak Balinit® Hardlube / Balinit® Hardlube coating / Balinit® Hardlube-Beschichtung
ALS	- povlak TiB2 / TiB2 coating / TiB2 - Beschichtung
OX	- oxidace / oxidation / Oxidieren
V_c	- řezná rychlost / cutting speed / Schnittgeschwindigkeit
	- řezná kapalina / cutting lubricant / Schneidflüssigkeit
E	- emulze / emulsion / Emulsion
O	- řezný olej / cutting oil / Schneidöl
IKZ	- vnitřní přívod chladicí kapaliny / internal axial coolant supply / innere Kühlmittelzufuhr axial
IKZN	- vnitřní přívod chladicí kapaliny s otvory v drážkách / internal axial coolant supply with hole outlets in the flutes / innere Kühlmittelzuführung axial mit Ölaustritt in den Nuten

	typ N - závitník pro oceli s pevností do 800 N/mm ² / tap for steels up to 800 N/mm ² / Gewindebohrer für Stähle bis 800 N/mm ²
	typ VA - závitník pro nerezavějící oceli / tap for stainless steels / Gewindebohrer für Rostfreistähle
	typ H - závitník pro zušlechtěné a legované oceli s pevností do 1100 N/mm ² / tap for alloyed steels up to 1100 N/mm ² / Gewindebohrer für Legiertestähle bis 1100 N/mm ²
	typ H - závitník pro zušlechtěné a legované oceli s pevností do 1400 N/mm ² / tap for alloyed steels up to 1400 N/mm ² / Gewindebohrer für Legiertestähle bis 1400 N/mm ²
	typ GG - závitník pro šedou litinu / tap for cast iron / Gewindebohrer für Grauguss
	typ AL - závitník pro hliník / tap for aluminium / Gewindebohrer für Aluminium
	typ UNI - závitník pro univerzální použití / tap for universal applications / Gewindebohrer für den universallen Einsatz

POSTUP PŘI VÝBĚRU ZÁVITNÍKU

How to find the best type of tap / Leitfaden zum optimalen Gewindebohrer

- Obráběný materiál zařadte do správné skupiny 1.1 ÷ 11.1 (str. 5 – 6).
Range the material to be threaded with the corresponding group 1.1 ÷ 11.1 (page no. 5 – 6).
Das zu bearbeitende Material in die richtige Gruppe 1.1 ÷ 11.1 (Seite 5 – 6).

4.2 Zusiecthene oceli po tepejnem zpracovani					
15142	1.7225	42CrMo4	4140, 4142	42 CD 4	
15260	1.8159	50CrV4	A 646 Gr.14	50 CD 4	
16523	1.5860	4NiCr18			
19452	1.2101	62SiMnCr4			
19552	1.2343	X38CrMoV5-1	H 11	Z 38 CDV 5	
19573	1.2379	X155CrVMo12-1	A 681 Type D2		

5 - Nerezavějící a žáruvzdorné oceli / Stainless steels and heat resisting steels / Rostfreistähle und Hitzebeständigstähle					
5.1 S pevností 450 - 800 N/mm ² / With strength 450 - 800 N/mm ² / Mit Festigkeit bis 450 - 800 N/mm ²					
17022	1.4021	X2Cr13	420	Z 20 C 13	
17040	1.4016	X6Cr17	430	Z 8 C 17	
17240	1.4301	X5CrNi18-10	304	Z 6 CN 18.09	
17241	1.4310	X10CrNi18-8	304 LN	Z 3 C 18.07Az	
17246	1.4878	X10CrNiTi18-10	A 479 Type 312 H	Z 6 CNT 18-12 B	
17350	1.4435	X2CrNiMo18-14-3	316 L	Z 3 CND 17.12.03	
17347	1.4571	X6CrNiMoTi17-12-2	A368 Type 316 Ti	Z6 CNDT 17-12	
422905	1.4006	X12Cr13	410	Z 10 C 13	

- V sekci "Volba závitníku dle obráběného materiálu" vyhledejte podle charakteru otvoru a druhu závitu odpovídající závitník, popř. jeho katalogové číslo – strana 9 ÷ 29.
Select the ring tap and its catalogue No. According to the hole type and the type of thread chosen in the section "Tap selection according to material groups" – page 9 ÷ 29.
In der Sektion "Gewindebohrerwahl gemäß den zu bearbeitenden Materialien" den entsprechenden Gewindebohrer (evtl. Katalognummer) gemäß der Bohrung und Gewinde entnehmen – Seite 9 ÷ 29.

SKUPINA OBRÁBĚNÉHO MATERIÁLU 5 / MATERIAL GROUP 5 / WERKSTOFFGRUPPE 5									
Nerezavějící a žáruvzdorné oceli Stainless steels and heat resisting steels Rostfreistähle und Hitzebeständigstähle									
Norma Standard	Kat. č. Cat. No.	Závit Thread	Rozsah Ø-Range	Typ otvoru Hole type	Použití Application	V _c m/min		Strana Page	
DIN 371	TiN	M	M3 ÷ M10	1; 2	5.1 5.2	8 ÷ 12 5 ÷ 8	0	38	
DIN 371	OX	M	M3 ÷ M10	1; 2	5.1 5.2	4 ÷ 7 3 ÷ 5	0	38	
DIN 371	HL	M	M3 ÷ M10	1; 2	5.1 5.2	8 ÷ 14 6 ÷ 10	0	38	
DIN 371	HL	M	M6 ÷ M10	1; 2	5.1 5.2	8 ÷ 14 6 ÷ 10	0	38	
DIN 376	TiN	M	M3 ÷ M36	1; 2	5.1 5.2	8 ÷ 12 5 ÷ 8	0	39	

- Úplnou specifikaci závitníku vyhledejte na příslušné straně katalogu.
See the full specification of the selected tap in the catalogue page.
Volle Gewindebohrerspezifikation im Katalog aussuchen.

Katalogové číslo / Cat. No. / Kat. Nr.									1660	1690	1870	1870 IKZ
									TiN	OX	HL	HL
z = počet drážek / z = number of flutes / z = Nutenzahl									HSSE	HSSE	HSSE PM	HSSE PM IKZ
d ₁	P	l ₁	l ₂	d ₂	a	z	Ø mm					
M 3	0,5	56	9	3,5	2,7	3	2,5	■	■	■		
M 3,5	0,6	56	11	4	3	3	2,9	■	■	■		
M 4	0,7	63	12	4,5	3,4	3	3,3	■	■	■		
M 4,5	0,75	70	13	6	4,9	3	3,7	■	■	■		
M 5	0,8	70	13	6	4,9	3	4,2	■	■	■		
M 6	1	80	15	6	4,9	3	5	■	■	■	■	
M 7	1	80	15	7	5,5	3	6	■	■	■	■	
M 8	1,25	90	18	8	6,2	3	6,8	■	■	■	■	
M 9	1,25	90	18	9	7	3	7,8	■	■	■	■	
M 10	1,5	100	20	10	8	3	8,5	■	■	■	■	

VOLBA ZÁVITNÍKU DLE OBRÁBĚNÉHO MATERIÁLU

TAP SELECTION ACCORDING TO MATERIAL GROUPS

GEWINDEBOHRERWAHL NACH WERKSTOFFGRUPPE

SKUPINA OBRÁBĚNÉHO MATERIÁLU 1 / MATERIAL GROUP 1 / WERKSTOFFGRUPPE 1

Měkké konstrukční oceli s pevností do 500 N/mm²
Soft structural steels up to 500 N/mm²
Weiche Baustähle bis 500 N/mm²

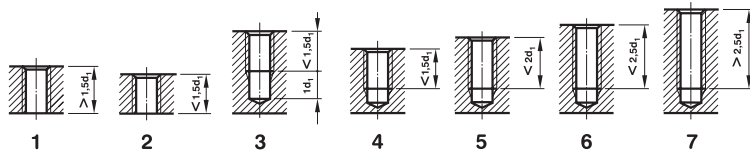

Norma Standard Norm		Kat. č. Cat. No. Kat. Nr.	Závit Thread Gewinde	Rozsah Ø-Range Abmessungsbereich	Typ otvoru Hole type Lochform	Použití Application Anwendung	V _c m/min		Strana Page Seite
DIN 371		1000	M	M3 ÷ M10	2; 3	1.1 ●	4 ÷ 6	0/E	30
DIN 371	TiN	1010	M	M3 ÷ M10	2; 3	1.1 ●	5 ÷ 8	0/E	30
DIN 376		3000	M	M3 ÷ M52	2; 3	1.1 ●	4 ÷ 6	0/E	31
DIN 376	TiN	3010	M	M3 ÷ M52	2; 3	1.1 ●	5 ÷ 8	0/E	31
DIN 371		1500	M	M2 ÷ M10	1; 2	1.1 ● 1.2 ●	5 ÷ 8 6 ÷ 10	0/E	32
DIN 371	TiN	1510	M	M2 ÷ M10	1; 2	1.1 ● 1.2 ●	6 ÷ 10 8 ÷ 12	0/E	32
DIN 371	OX	1540	M	M2 ÷ M10	1; 2	1.2 ●	6 ÷ 10	0/E	32
DIN 371		1750	M	M3 ÷ M10	1; 2	1.1; 1.2 ●	5 ÷ 8	0/E	32
DIN 376		3500	M	M3 ÷ M36	1; 2	1.1 ● 1.2 ●	5 ÷ 8 6 ÷ 10	0/E	33
DIN 376	TiN	3510	M	M3 ÷ M36	1; 2	1.1 ● 1.2 ●	6 ÷ 10 8 ÷ 12	0/E	33
DIN 376	OX	3540	M	M3 ÷ M36	1; 2	1.2 ●	6 ÷ 10	0/E	33
DIN 371	TiN	2360	M	M3 ÷ M10	3; 4; 5	1.1 ● 1.2 ●	8 ÷ 12 10 ÷ 15	0/E	36
DIN 371	OX	2390	M	M3 ÷ M10	3; 4; 5	1.1 ● 1.2 ●	5 ÷ 8 6 ÷ 10	0/E	36
DIN 376	TiN	4360	M	M3 ÷ M36	3; 4; 5	1.1 ● 1.2 ●	8 ÷ 12 10 ÷ 15	0/E	37
DIN 376	OX	4390	M	M3 ÷ M36	3; 4; 5	1.1 ● 1.2 ●	5 ÷ 8 6 ÷ 10	0/E	37
DIN 352		0550	M	M3 ÷ M12	1; 2	1.1 ● 1.2 ●	5 ÷ 8 6 ÷ 10	0/E	67
DIN 2174	TiN	2910	M	M3 ÷ M12	1 ÷ 7	1.1 ●	12 ÷ 20	0/E	68
DIN 2174	TiN	2960	M	M3 ÷ M12	1 ÷ 7	1.1 ● 1.2 ●	15 ÷ 25 12 ÷ 20	0/E	68
DIN 374		3000	MF	M3 ÷ M52	2; 3	1.1 ●	4 ÷ 6	0/E	49
DIN 374	TiN	3010	MF	M3 ÷ M52	2; 3	1.1 ●	5 ÷ 8	0/E	49
DIN 374		3500	MF	M3 ÷ M36	1; 2	1.1 ● 1.2 ●	5 ÷ 8 6 ÷ 10	0/E	49
DIN 374	TiN	3510	MF	M3 ÷ M36	1; 2	1.1 ● 1.2 ●	6 ÷ 10 8 ÷ 12	0/E	49
DIN 374	OX	3540	MF	M3 ÷ M36	1; 2	1.2 ●	6 ÷ 10	0/E	49
DIN 5156		3002	G	G1/16" ÷ G2"	2; 3	1.1 ●	4 ÷ 6	0/E	59
DIN 5156	TiN	3012	G	G1/16" ÷ G2"	2; 3	1.1 ●	5 ÷ 8	0/E	59
DIN 5156		3502	G	G1/16" ÷ G2"	1; 2	1.1 ● 1.2 ●	5 ÷ 8 6 ÷ 10	0/E	59
DIN 5156	TiN	3512	G	G1/16" ÷ G2"	1; 2	1.1 ● 1.2 ●	6 ÷ 10 8 ÷ 12	0/E	59
~ DIN 371		1004	UNC	5-40 ÷ 3/8-16	2; 3	1.1 ●	4 ÷ 6	0/E	62

● doporučené užití / recommended use / optimal

● možno použít / possible use / geeignet

VOLBA ZÁVITNÍKU DLE OBRÁBĚNÉHO MATERIÁLU TAP SELECTION ACCORDING TO MATERIAL GROUPS GEWINDEBOHRERWAHL NACH WERKSTOFFGRUPPE

SKUPINA OBRÁBĚNÉHO MATERIÁLU 1 / MATERIAL GROUP 1 / WERKSTOFFGRUPPE 1

Měkké konstrukční oceli s pevností do 500 N/mm²
Soft structural steels up to 500 N/mm²
Weiche Baustähle bis 500 N/mm²

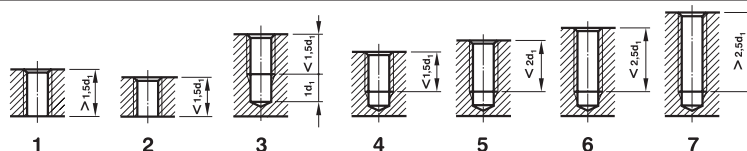

Norma Standard Norm			Kat. č. Cat. No. Kat. Nr.	Závit Thread Gewinde	Rozsah Ø-Range Abmessungsbereich	Typ otvoru Hole type Lochform	Použití Application Anwendung		V _c m/min		Strana Page Seite
~ DIN 371	TiN		1014	UNC	5-40 ÷ 3/8-16	2;3	1.1	●	5 ÷ 8	0/E	62
~ DIN 376			3004	UNC	7/16-14 ÷ 1/8-7	2;3	1.1	●	4 ÷ 6	0/E	63
~ DIN 376	TiN		3014	UNC	7/16-14 ÷ 1/8-7	2;3	1.1	●	5 ÷ 8	0/E	63
~ DIN 371			1504	UNC	5-40 ÷ 3/8-16	1;2	1.1 1.2	●	5 ÷ 8 6 ÷ 10	0/E	62
~ DIN 371	TiN		1514	UNC	5-40 ÷ 3/8-16	1;2	1.1 1.2	●	6 ÷ 10 8 ÷ 12	0/E	62
~ DIN 376			3504	UNC	7/16-14 ÷ 1/8-7	1;2	1.1 1.2	●	5 ÷ 8 6 ÷ 10	0/E	63
~ DIN 376	TiN		3514	UNC	7/16-14 ÷ 1/8-7	1;2	1.1 1.2	●	6 ÷ 10 8 ÷ 12	0/E	63
~ DIN 374			3005	UNF	5-44 ÷ 1/8-12	2;3	1.1	●	4 ÷ 6	0/E	65
~ DIN 374	TiN		3015	UNF	5-44 ÷ 1/8-12	2;3	1.1	●	5 ÷ 8	0/E	65
~ DIN 374			3505	UNF	5-44 ÷ 1/8-12	1;2	1.1 1.2	●	5 ÷ 8 6 ÷ 10	0/E	65
~ DIN 374	TiN		3515	UNF	5-44 ÷ 1/8-12	1;2	1.1 1.2	●	6 ÷ 10 8 ÷ 12	0/E	65

● doporučené užití / recommended use / optimal

● možno použít / possible use / geeignet

VOLBA ZÁVITNÍKU DLE OBRÁBĚNÉHO MATERIÁLU

TAP SELECTION ACCORDING TO MATERIAL GROUPS

GEWINDEBOHRERWAHL NACH WERKSTOFFGRUPPE

SKUPINA OBRÁBĚNÉHO MATERIÁLU 2 / MATERIAL GROUP 2 / WERKSTOFFGRUPPE 2

Automatové a konstrukční oceli s pevností do 800 N/mm²
Free cutting steels and structural steels up to 800 N/mm²
Automatenstähle und Baustähle bis 800 N/mm²

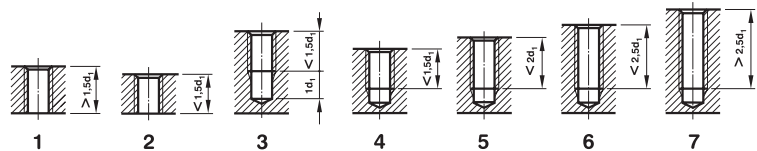

Norma Standard Norm		Kat. č. Cat. No. Kat. Nr.	Závit Thread Gewinde	Rozsah Ø-Range Abmessungsbereich	Typ otvoru Hole type Lochform	Použití Application Anwendung	V _c m/min		Strana Page Seite
DIN 371		1000	M	M3 ÷ M10	2; 3	2.1 ●	8 ÷ 10	0/E	30
DIN 371	TiN	1010	M	M3 ÷ M10	2; 3	2.1 ●	10 ÷ 14	0/E	30
DIN 376		3000	M	M3 ÷ M52	2; 3	2.1 ●	8 ÷ 10	0/E	31
DIN 376	TiN	3010	M	M3 ÷ M52	2; 3	2.1 ●	10 ÷ 14	0/E	31
DIN 371		1500	M	M2 ÷ M10	1; 2	2.1; 2.3 ● 2.2 ●	10 ÷ 14	0/E	32
DIN 371	TiN	1510	M	M2 ÷ M10	1; 2	2.1 ● 2.2; 2.3 ●	10 ÷ 14 12 ÷ 15	0/E	32
DIN 371	OX	1540	M	M2 ÷ M10	1; 2	2.2 ● 2.3 ●	10 ÷ 12 12 ÷ 15	0/E	32
DIN 371		1750	M	M3 ÷ M10	1; 2	2.1 ● 2.2; 2.3 ●	8 ÷ 10 8 ÷ 12	0/E	32
DIN 376		3500	M	M3 ÷ M36	1; 2	2.1; 2.3 ● 2.2 ●	10 ÷ 14	0/E	33
DIN 376	TiN	3510	M	M3 ÷ M36	1; 2	2.1 ● 2.2; 2.3 ●	10 ÷ 14 12 ÷ 15	0/E	33
DIN 376	OX	3540	M	M3 ÷ M36	1; 2	2.2 ● 2.3 ●	10 ÷ 12 12 ÷ 15	0/E	33
DIN 371		2050	M	M2 ÷ M10	3; 4; 5	2.2; 2.3 ●	10 ÷ 14	0/E	34
DIN 371	TiN	2060	M	M2 ÷ M10	3; 4; 5	2.2; 2.3 ●	12 ÷ 15	0/E	34
DIN 371	OX	2090	M	M2 ÷ M10	3; 4; 5	2.2; 2.3 ●	10 ÷ 12	0/E	34
DIN 376		4050	M	M3 ÷ M36	3; 4; 5	2.2; 2.3 ●	10 ÷ 14	0/E	35
DIN 376	TiN	4060	M	M3 ÷ M36	3; 4; 5	2.2; 2.3 ●	12 ÷ 15	0/E	35
DIN 376	OX	4090	M	M3 ÷ M36	3; 4; 5	2.2; 2.3 ●	10 ÷ 12	0/E	35
DIN 371		2400	M	M3 ÷ M10	3; 4	2.2 ●	8 ÷ 10	0/E	36
DIN 371	TiN	2410	M	M3 ÷ M10	3; 4	2.2 ●	8 ÷ 12	0/E	36
DIN 376		4400	M	M3 ÷ M36	3; 4	2.2 ●	8 ÷ 10	0/E	37
DIN 376	TiN	4410	M	M3 ÷ M36	3; 4	2.2 ●	8 ÷ 12	0/E	37
DIN 371	TiN	2360	M	M3 ÷ M10	3; 4; 5	2.1 ● 2.2 ●	12 ÷ 15 10 ÷ 14	0/E	36
DIN 371	OX	2390	M	M3 ÷ M10	3; 4; 5	2.1 ● 2.2 ●	12 ÷ 15 10 ÷ 12	0/E	36
DIN 376	TiN	4360	M	M3 ÷ M36	3; 4; 5	2.1 ● 2.2 ●	12 ÷ 15 10 ÷ 14	0/E	37
DIN 376	OX	4390	M	M3 ÷ M36	3; 4; 5	2.1 ● 2.2 ●	12 ÷ 15 10 ÷ 12	0/E	37
DIN 371	TiN	1710	M	M3 ÷ M10	1; 2	2.1 ● 2.2 ●	10 ÷ 12	0/E	48
DIN 376	TiN	3710	M	M12 ÷ M20	1; 2	2.1 ● 2.2 ●	10 ÷ 12	0/E	48
DIN 371	TiN	2210	M	M3 ÷ M10	3; 4; 5	2.1 ● 2.2 ●	8 ÷ 10	0/E	48

● doporučené užití / recommended use / optimal

● možno použít / possible use / geeignet

VOLBA ZÁVITNÍKU DLE OBRÁBĚNÉHO MATERIÁLU

TAP SELECTION ACCORDING TO MATERIAL GROUPS

GEWINDEBOHRERWAHL NACH WERKSTOFFGRUPPE

SKUPINA OBRÁBĚNÉHO MATERIÁLU 2 / MATERIAL GROUP 2 / WERKSTOFFGRUPPE 2

Automatové a konstrukční oceli s pevností do 800 N/mm²
 Free cutting steels and structural steels up to 800 N/mm²
 Automatenstähle und Baustähle bis 800 N/mm²

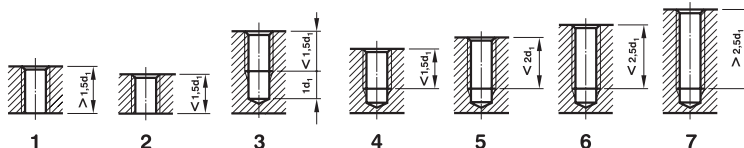

Norma Standard Norm		Kat. č. Cat. No. Kat. Nr.	Závit Thread Gewinde	Rozsah Ø-Range Abmessungsbereich	Typ otvoru Hole type Lochform	Použití Application Anwendung	V _c m/min		Strana Page Seite		
DIN 376	TiN		4210	M	M12 ÷ M20	3; 4; 5	2.1 2.2	● ●	8 ÷ 10	O/E	48
DIN 352			0550	M	M3 ÷ M12	1; 2	2.1; 2.3 2.2	● ●	10 ÷ 14	O/E	67
DIN 352			0600	M	M3 ÷ M12	3; 4	2.2; 2.3	●	10 ÷ 14	O/E	67
DIN 352			0650	M	M3 ÷ M12	3; 4	2.2	●	8 ÷ 10	O/E	67
DIN 2174	TiN		2910	M	M3 ÷ M12	1 ÷ 7	2.1; 2.2	●	15 ÷ 20	O/E	68
DIN 2174	TiN		2960	M	M3 ÷ M12	1 ÷ 7	2.1 2.2	● ●	20 ÷ 25	O/E	68
DIN 374			3000	MF	M3 ÷ M52	2; 3	2.1	●	8 ÷ 10	O/E	49
DIN 374	TiN		3010	MF	M3 ÷ M52	2; 3	2.1	●	10 ÷ 14	O/E	49
DIN 374			3500	MF	M3 ÷ M36	1; 2	2.1; 2.3 2.2	● ●	10 ÷ 14	O/E	49
DIN 374	TiN		3510	MF	M3 ÷ M36	1; 2	2.1 2.2; 2.3	● ●	10 ÷ 14 12 ÷ 15	O/E	49
DIN 374	OX		3540	MF	M3 ÷ M36	1; 2	2.2 2.3	● ●	10 ÷ 12 12 ÷ 15	O/E	49
DIN 374			4050	MF	M3 ÷ M36	3; 4; 5	2.2; 2.3	●	10 ÷ 14	O/E	51
DIN 374	TiN		4060	MF	M3 ÷ M36	3; 4; 5	2.2; 2.3	●	12 ÷ 15	O/E	51
DIN 374	OX		4090	MF	M3 ÷ M36	3; 4; 5	2.2; 2.3	●	10 ÷ 12	O/E	51
DIN 5156			3002	G	G1/16" ÷ G2"	2; 3	2.1	●	8 ÷ 10	O/E	59
DIN 5156	TiN		3012	G	G1/16" ÷ G2"	2; 3	2.1	●	10 ÷ 14	O/E	59
DIN 5156			3502	G	G1/16" ÷ G2"	1; 2	2.1; 2.3 2.2	● ●	10 ÷ 14	O/E	59
DIN 5156	TiN		3512	G	G1/16" ÷ G2"	1; 2	2.1 2.2; 2.3	● ●	10 ÷ 14 12 ÷ 15	O/E	59
DIN 5156			4052	G	G1/16" ÷ G11/2"	3; 4; 5	2.2; 2.3	●	10 ÷ 14	O/E	60
DIN 5156	TiN		4062	G	G1/16" ÷ G11/2"	3; 4; 5	2.2; 2.3	●	12 ÷ 15	O/E	60
~ DIN 371			1004	UNC	5-40 ÷ 3/8-16	2; 3	2.1	●	8 ÷ 10	O/E	62
~ DIN 371	TiN		1014	UNC	5-40 ÷ 3/8-16	2; 3	2.1	●	10 ÷ 14	O/E	62
~ DIN 376			3004	UNC	7/16-14 ÷ 11/8-7	2; 3	2.1	●	8 ÷ 10	O/E	63
~ DIN 376	TiN		3014	UNC	7/16-14 ÷ 11/8-7	2; 3	2.1	●	10 ÷ 14	O/E	63
~ DIN 371			1504	UNC	5-40 ÷ 3/8-16	1; 2	2.1; 2.3 2.2	● ●	10 ÷ 14	O/E	62
~ DIN 371	TiN		1514	UNC	5-40 ÷ 3/8-16	1; 2	2.1 2.2; 2.3	● ●	10 ÷ 14 12 ÷ 15	O/E	62
~ DIN 376			3504	UNC	7/16-14 ÷ 11/8-7	1; 2	2.1; 2.3 2.2	● ●	10 ÷ 14	O/E	63
~ DIN 376	TiN		3514	UNC	7/16-14 ÷ 11/8-7	1; 2	2.1 2.2; 2.3	● ●	10 ÷ 14 12 ÷ 15	O/E	63

● doporučené užití / recommended use / optimal

● možno použít / possible use / geeignet

VOLBA ZÁVITNÍKU DLE OBRÁBĚNÉHO MATERIÁLU







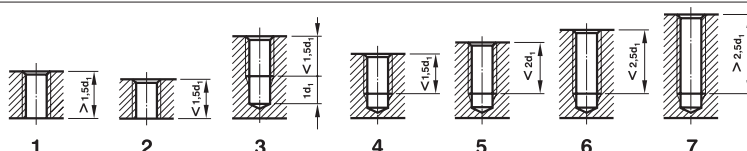

TAP SELECTION ACCORDING TO MATERIAL GROUPS

GEWINDEBOHRERWAHL NACH WERKSTOFFGRUPPE

SKUPINA OBRÁBĚNÉHO MATERIÁLU 2 / MATERIAL GROUP 2 / WERKSTOFFGRUPPE 2

Automatové a konstrukční oceli s pevností do 800 N/mm²
Free cutting steels and structural steels up to 800 N/mm²
Automatenstähle und Baustähle bis 800 N/mm²



Norma Standard Norm		Kat. č. Cat. No. Kat. Nr.	Závit Thread Gewinde	Rozsah Ø-Range Abmessungsbereich	Typ otvoru Hole type Lochform	Použití Application Anwendung	V _c m/min		Strana Page Seite
~ DIN 371		2054	UNC	5-40 ÷ 3/8-16	3; 4; 5	2.2; 2.3 ●	10 ÷ 14	0/E	64
~ DIN 371	TiN 	2064	UNC	5-40 ÷ 3/8-16	3; 4; 5	2.2; 2.3 ●	12 ÷ 15	0/E	64
~ DIN 376		4054	UNC	7/16-14 ÷ 1-8	3; 4; 5	2.2; 2.3 ●	10 ÷ 14	0/E	64
~ DIN 376	TiN 	4064	UNC	7/16-14 ÷ 1-8	3; 4; 5	2.2; 2.3 ●	12 ÷ 15	0/E	64
~ DIN 374		3005	UNF	5-44 ÷ 11/8-12	2; 3	2.1 ●	8 ÷ 10	0/E	65
~ DIN 374	TiN 	3015	UNF	5-44 ÷ 11/8-12	2; 3	2.1 ●	10 ÷ 14	0/E	65
~ DIN 374		3505	UNF	5-44 ÷ 11/8-12	1; 2	2.1; 2.3 2.2 ●	10 ÷ 14	0/E	65
~ DIN 374	TiN 	3515	UNF	5-44 ÷ 11/8-12	1; 2	2.1 2.2; 2.3 ●	10 ÷ 14 12 ÷ 15	0/E	65
~ DIN 374		4055	UNF	5-44 ÷ 1-12	3; 4; 5	2.2; 2.3 ●	10 ÷ 14	0/E	66
~ DIN 374	TiN 	4065	UNF	5-44 ÷ 1-12	3; 4; 5	2.2; 2.3 ●	12 ÷ 15	0/E	66

● doporučené užití / recommended use / optimal ● možno použít / possible use / geeignet

VOLBA ZÁVITNÍKU DLE OBRÁBĚNÉHO MATERIÁLU

TAP SELECTION ACCORDING TO MATERIAL GROUPS

GEWINDEBOHRERWAHL NACH WERKSTOFFGRUPPE

SKUPINA OBRÁBĚNÉHO MATERIÁLU 3 / MATERIAL GROUP 3 / WERKSTOFFGRUPPE 3

Zuřlechtěné a nástrojové oceli s pevností do 1100 N/mm²
Heat-treated steels and tool steels up to 1100 N/mm²
Vergütungsstähle und Werkzeugstähle bis 1100 N/mm²

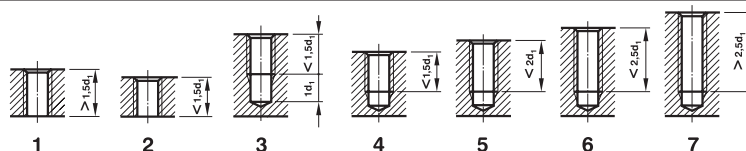

Norma Standard Norm			Kat. č. Cat. No. Kat. Nr.	Závít Thread Gewinde	Rozsah Ø-Range Abmessungsbereich	Typ otvoru Hole type Lochform	Použití Application Anwendung	V _c m/min		Strana Page Seite
DIN 371	TiN		1660	M	M3 ÷ M10	1;2	3.1 ●	4 ÷ 8	O/E	38
DIN 371	OX		1690	M	M3 ÷ M10	1;2	3.1 ●	3 ÷ 5	0	38
DIN 371	HL		1870	M	M3 ÷ M10	1;2	3.1 ● 3.3 ●	6 ÷ 8 4 ÷ 6	O/E	38
DIN 371	HL		1870 IKZN	M	M6 ÷ M10	1;2	3.1 ● 3.3 ●	6 ÷ 8 4 ÷ 6	O/E	38
DIN 376	TiN		3660	M	M3 ÷ M36	1;2	3.1 ●	4 ÷ 8	O/E	39
DIN 376	OX		3690	M	M3 ÷ M36	1;2	3.1 ●	3 ÷ 5	0	39
DIN 376	HL		3870	M	M12	1;2	3.1 ● 3.3 ●	6 ÷ 8 4 ÷ 6	O/E	39
DIN 376	HL		3870 IKZN	M	M12	1;2	3.1 ● 3.3 ●	6 ÷ 8 4 ÷ 6	O/E	39
DIN 371	TiN		2260	M	M3 ÷ M10	3;4;5	3.1;3.3 ●	6 ÷ 8	O/E	40
DIN 371	OX		2290	M	M3 ÷ M10	3;4;5	3.1 ●	3 ÷ 5	0	40
DIN 371	HL		2320	M	M3 ÷ M10	3;4;5	3.1;3.3 ● 3.2 ●	6 ÷ 8 4 ÷ 6	O/E	40
DIN 371	HL		2320 IKZ	M	M5 ÷ M10	3;4;5	3.1;3.3 ● 3.2 ●	6 ÷ 8 4 ÷ 6	O/E	40
DIN 376	TiN		4260	M	M3 ÷ M36	3;4;5	3.1;3.3 ●	6 ÷ 8	O/E	41
DIN 376	OX		4290	M	M3 ÷ M36	3;4;5	3.1 ●	3 ÷ 5	0	41
DIN 376	HL		4320	M	M12	3;4;5	3.1;3.3 ● 3.2 ●	6 ÷ 8 4 ÷ 6	O/E	41
DIN 376	HL		4320 IKZ	M	M12	3;4;5	3.1;3.3 ● 3.2 ●	6 ÷ 8 4 ÷ 6	O/E	41
DIN 371	TiCN		1580	M	M3 ÷ M10	1;2	3.1;3.2;3.3 ●	4 ÷ 8	O/E	42
DIN 371	OX		1590	M	M3 ÷ M10	1;2	3.2 ●	4 ÷ 8	0	42
DIN 376	TiCN		3580	M	M3 ÷ M36	1;2	3.1;3.2;3.3 ●	4 ÷ 8	O/E	43
DIN 376	OX		3590	M	M3 ÷ M36	1;2	3.2 ●	4 ÷ 8	0	43
DIN 371	TiCN		2680	M	M3 ÷ M10	3;4;5	3.1;3.3 ● 3.2 ●	3 ÷ 5 6 ÷ 8	O/E	42
DIN 371	OX		2690	M	M3 ÷ M10	3;4;5	3.2 ●	3 ÷ 5	0	42
DIN 376	TiCN		4680	M	M3 ÷ M36	3;4;5	3.1;3.3 ● 3.2 ●	3 ÷ 5 6 ÷ 8	O/E	43
DIN 376	OX		4690	M	M3 ÷ M36	3;4;5	3.2 ●	3 ÷ 5	0	43
DIN 371	TiN		1710	M	M3 ÷ M10	1;2	3.1;3.2;3.3 ●	4 ÷ 6	O/E	48
DIN 376	TiN		3710	M	M12 ÷ M20	1;2	3.1;3.2;3.3 ●	4 ÷ 6	O/E	48
DIN 371	TiN		2210	M	M3 ÷ M10	3;4;5	3.1;3.2;3.3 ●	4 ÷ 6	O/E	48
DIN 376	TiN		4210	M	M12 ÷ M20	3;4;5	3.1;3.2;3.3 ●	4 ÷ 6	O/E	48

● doporučené užití / recommended use / optimal

● možno použít / possible use / geeignet

VOLBA ZÁVITNÍKU DLE OBRÁBĚNÉHO MATERIÁLU

TAP SELECTION ACCORDING TO MATERIAL GROUPS

GEWINDEBOHRERWAHL NACH WERKSTOFFGRUPPE

SKUPINA OBRÁBĚNÉHO MATERIÁLU 5 / MATERIAL GROUP 5 / WERKSTOFFGRUPPE 5

Nerezavějící a žáruvzdorné oceli
Stainless steels and heat resisting steels
Rostfreistähle und Hitzebeständigstähle

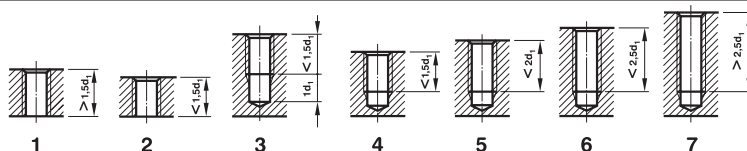

Norma Standard Norm			Kat. č. Cat. No. Kat. Nr.	Závit Thread Gewinde	Rozsah Ø-Range Abmessungsbereich	Typ otvoru Hole type Lochform	Použití Application Anwendung	V _c m/min		Strana Page Seite
DIN 371	TiN		1660	M	M3 ÷ M10	1; 2	5.1 5.2 ●	8 ÷ 12 5 ÷ 8	0	38
DIN 371	OX		1690	M	M3 ÷ M10	1; 2	5.1 5.2 ●	4 ÷ 7 3 ÷ 5	0	38
DIN 371	HL		1870	M	M3 ÷ M10	1; 2	5.1 5.2 ●	8 ÷ 14 6 ÷ 10	0	38
DIN 371	HL		1870 IKZN	M	M6 ÷ M10	1; 2	5.1 5.2 ●	8 ÷ 14 6 ÷ 10	0	38
DIN 376	TiN		3660	M	M3 ÷ M36	1; 2	5.1 5.2 ●	8 ÷ 12 5 ÷ 8	0	39
DIN 376	OX		3690	M	M3 ÷ M36	1; 2	5.1 5.2 ●	4 ÷ 7 3 ÷ 5	0	39
DIN 376	HL		3870	M	M12	1; 2	5.1 5.2 ●	8 ÷ 14 6 ÷ 10	0	39
DIN 376	HL		3870 IKZN	M	M12	1; 2	5.1 5.2 ●	8 ÷ 14 6 ÷ 10	0	39
DIN 371	TiN		2260	M	M3 ÷ M10	3; 4; 5	5.1 5.2 ●	8 ÷ 14 6 ÷ 10	0	40
DIN 371	OX		2290	M	M3 ÷ M10	3; 4; 5	5.1 5.2 ●	4 ÷ 7 3 ÷ 5	0	40
DIN 371	HL		2320	M	M3 ÷ M10	3; 4; 5	5.1 5.2 ●	8 ÷ 14 6 ÷ 10	0	40
DIN 371	HL		2320 IKZ	M	M5 ÷ M10	3; 4; 5	5.1 5.2 ●	8 ÷ 14 6 ÷ 10	0	40
DIN 376	TiN		4260	M	M3 ÷ M36	3; 4; 5	5.1 5.2 ●	8 ÷ 14 6 ÷ 10	0	41
DIN 376	OX		4290	M	M3 ÷ M36	3; 4; 5	5.1 5.2 ●	4 ÷ 7 3 ÷ 5	0	41
DIN 376	HL		4320	M	M12	3; 4; 5	5.1 5.2 ●	8 ÷ 14 6 ÷ 10	0	41
DIN 376	HL		4320 IKZ	M	M12	3; 4; 5	5.1 5.2 ●	8 ÷ 14 6 ÷ 10	0	41
DIN 371	TiN		1710	M	M3 ÷ M10	1; 2	5.1 5.2 ●	6 ÷ 10 4 ÷ 7	0	48
DIN 376	TiN		3710	M	M12 ÷ M20	1; 2	5.1 5.2 ●	6 ÷ 10 4 ÷ 7	0	48
DIN 371	TiN		2210	M	M3 ÷ M10	3; 4; 5	5.1 5.2 ●	6 ÷ 10 4 ÷ 7	0	48
DIN 376	TiN		4210	M	M12 ÷ M20	3; 4; 5	5.1 5.2 ●	6 ÷ 10 4 ÷ 7	0	48
DIN 374	TiN		3660	MF	M3 ÷ M36	1; 2	5.1 5.2 ●	8 ÷ 12 5 ÷ 8	0	53
DIN 374	OX		3690	MF	M3 ÷ M36	1; 2	5.1 5.2 ●	4 ÷ 7 3 ÷ 5	0	53
DIN 374	TiN		4260	MF	M3 ÷ M36	3; 4; 5	5.1 5.2 ●	8 ÷ 14 6 ÷ 10	0	53
DIN 374	OX		4290	MF	M3 ÷ M36	3; 4; 5	5.1 5.2 ●	4 ÷ 7 3 ÷ 5	0	53
DIN 5156	TiN		3662	G	G1/16" ÷ G11/2"	1; 2	5.1 5.2 ●	8 ÷ 12 5 ÷ 8	0	61
DIN 5156	OX		3692	G	G1/16" ÷ G11/2"	1; 2	5.1 5.2 ●	4 ÷ 7 3 ÷ 5	0	61
DIN 5156	TiN		4262	G	G1/16" ÷ G11/2"	3; 4; 5	5.1 5.2 ●	8 ÷ 14 6 ÷ 10	0	61
DIN 5156	OX		4292	G	G1/16" ÷ G11/2"	3; 4; 5	5.1 5.2 ●	4 ÷ 7 3 ÷ 5	0	61

● doporučené užití / recommended use / optimal

● možno použít / possible use / geeignet

VOLBA ZÁVITNÍKU DLE OBRÁBĚNÉHO MATERIÁLU

TAP SELECTION ACCORDING TO MATERIAL GROUPS

GEWINDEBOHRERWAHL NACH WERKSTOFFGRUPPE

SKUPINA OBRÁBĚNÉHO MATERIÁLU 6 / MATERIAL GROUP 6 / WERKSTOFFGRUPPE 6

Litiny Cast iron Gusswerkstoffe							
	1	2	3	4	5	6	7

Norma Standard Norm		Kat. č. Cat. No. Kat. Nr.	Závit Thread Gewinde	Rozsah Ø-Range Abmessungsbereich	Typ otvoru Hole type Lochform	Použití Application Anwendung	V_c m/min		Strana Page Seite
DIN 371		1000	M	M3 ÷ M10	1 ÷ 6	6.1 ●	7 ÷ 10	E	30
DIN 371	TiN	1010	M	M3 ÷ M10	1 ÷ 6	6.1 ●	8 ÷ 12	E	30
DIN 376		3000	M	M3 ÷ M52	1 ÷ 6	6.1 ●	7 ÷ 10	E	31
DIN 376	TiN	3010	M	M3 ÷ M52	1 ÷ 6	6.1 ●	8 ÷ 12	E	31
DIN 371		1500	M	M3 ÷ M10	1; 2; 3	6.2 ●	4 ÷ 7	E	32
DIN 371	TiN	1510	M	M3 ÷ M10	1; 2; 3	6.2 ●	6 ÷ 8	E	32
DIN 376		3500	M	M3 ÷ M36	1; 2; 3	6.2 ●	4 ÷ 7	E	33
DIN 376	TiN	3510	M	M3 ÷ M36	1; 2; 3	6.2 ●	6 ÷ 8	E	33
DIN 371		2050	M	M3 ÷ M10	3; 4; 5; 6	6.2 ●	4 ÷ 7	E	34
DIN 371	TiN	2060	M	M3 ÷ M10	3; 4; 5; 6	6.2 ●	6 ÷ 8	E	34
DIN 376		4050	M	M3 ÷ M36	3; 4; 5; 6	6.2 ●	4 ÷ 7	E	35
DIN 376	TiN	4060	M	M3 ÷ M36	3; 4; 5; 6	6.2 ●	6 ÷ 8	E	35
DIN 371	TiN	2410	M	M3 ÷ M10	1 ÷ 6	6.2 ●	4 ÷ 7	E	36
DIN 376	TiN	4410	M	M3 ÷ M36	1 ÷ 6	6.2 ●	4 ÷ 7	E	37
DIN 371	TiN	2260	M	M3 ÷ M10	3; 4; 5; 6	6.2 ●	7 ÷ 10	E	40
DIN 376	TiN	4260	M	M3 ÷ M36	3; 4; 5; 6	6.2 ●	7 ÷ 10	E	41
DIN 371	TiCN	1580	M	M3 ÷ M10	1; 2; 3	6.2 ●	7 ÷ 10	E	42
DIN 376	TiCN	3580	M	M3 ÷ M36	1; 2; 3	6.2 ●	7 ÷ 10	E	43
DIN 371	TiCN	2680	M	M3 ÷ M10	3; 4; 5; 6	6.2 ●	7 ÷ 10	E	42
DIN 376	TiCN	4680	M	M3 ÷ M36	3; 4; 5; 6	6.2 ●	7 ÷ 10	E	43
DIN 371	TiCN	1080	M	M3 ÷ M10	1 ÷ 6	6.1 ●	15 ÷ 20	E	46
DIN 371	TiCN	1080 IKZ	M	M5 ÷ M10	1 ÷ 6	6.1 ●	15 ÷ 20	E	46
DIN 371	TiCN	1130	M	M3 ÷ M10	1 ÷ 6	6.1 ●	15 ÷ 20	E	46
DIN 371	TiCN	1130 IKZ	M	M5 ÷ M10	1 ÷ 6	6.1 ●	15 ÷ 20	E	46
DIN 376	TiCN	3080	M	M3 ÷ M52	1 ÷ 6	6.1 ●	15 ÷ 20	E	47
DIN 376	TiCN	3080 IKZ	M	M5 ÷ M52	1 ÷ 6	6.1 ●	15 ÷ 20	E	47
DIN 376	TiCN	3130	M	M3 ÷ M52	1 ÷ 6	6.1 ●	15 ÷ 20	E	47
DIN 376	TiCN	3130 IKZ	M	M5 ÷ M52	1 ÷ 6	6.1 ●	15 ÷ 20	E	47

● doporučené užití / recommended use / optimal

● možno použít / possible use / geeignet

VOLBA ZÁVITNÍKU DLE OBRÁBĚNÉHO MATERIÁLU

TAP SELECTION ACCORDING TO MATERIAL GROUPS

GEWINDEBOHRERWAHL NACH WERKSTOFFGRUPPE

SKUPINA OBRÁBĚNÉHO MATERIÁLU 6 / MATERIAL GROUP 6 / WERKSTOFFGRUPPE 6

Litiny Cast iron Gusswerkstoffe							
	1	2	3	4	5	6	7

Norma Standard Norm			Kat. Ā. Cat. No. Kat. Nr.	Závit Thread Gewinde	Rozsah Ø-Range Abmessungsbereich	Typ otvoru Hole type Lochform	Použití Application Anwendung	V _c m/min		Strana Page Seite
DIN 371	TiN		1710	M	M3 ÷ M10	1; 2; 3	6.1 6.2 ●	8 ÷ 12 7 ÷ 10	E	48
DIN 376	TiN		3710	M	M12 ÷ M20	1; 2; 3	6.1 6.2 ●	8 ÷ 12 7 ÷ 10	E	48
DIN 371	TiN		2210	M	M3 ÷ M10	3; 4; 5; 6	6.1 6.2 ●	8 ÷ 12 7 ÷ 10	E	48
DIN 376	TiN		4210	M	M12 ÷ M20	3; 4; 5; 6	6.1 6.2 ●	8 ÷ 12 7 ÷ 10	E	48
DIN 352			0550	M	M3 ÷ M12	1; 2; 3	6.2 ●	4 ÷ 7	E	67
DIN 352			0600	M	M3 ÷ M12	3; 4; 5; 6	6.2 ●	4 ÷ 7	E	67
DIN 374			3000	MF	M3 ÷ M52	1 ÷ 6	6.1 ●	7 ÷ 10	E	49
DIN 374	TiN		3010	MF	M3 ÷ M52	1 ÷ 6	6.1 ●	8 ÷ 12	E	49
DIN 374			3500	MF	M3 ÷ M36	1; 2; 3	6.2 ●	4 ÷ 7	E	49
DIN 374	TiN		3510	MF	M3 ÷ M36	1; 2; 3	6.2 ●	6 ÷ 8	E	49
DIN 374			4050	MF	M3 ÷ M36	3; 4; 5; 6	6.2 ●	4 ÷ 7	E	51
DIN 374	TiN		4060	MF	M3 ÷ M36	3; 4; 5; 6	6.2 ●	6 ÷ 8	E	51
DIN 374	TiN		4260	MF	M3 ÷ M36	3; 4; 5; 6	6.2 ●	7 ÷ 10	E	53
DIN 374	TiCN		3580	MF	M3 ÷ M36	1; 2; 3	6.2 ●	7 ÷ 10	E	55
DIN 374	TiCN		4680	MF	M3 ÷ M36	3; 4; 5; 6	6.2 ●	7 ÷ 10	E	55
DIN 374	TiCN		3080	MF	M3 ÷ M52	1 ÷ 6	6.1 ●	15 ÷ 20	E	57
DIN 374	TiCN		3080 IKZ	MF	M5 ÷ M52	1 ÷ 6	6.1 ●	15 ÷ 20	E	57
DIN 374	TiCN		3130	MF	M3 ÷ M52	1 ÷ 6	6.1 ●	15 ÷ 20	E	57
DIN 374	TiCN		3130 IKZ	MF	M5 ÷ M52	1 ÷ 6	6.1 ●	15 ÷ 20	E	57
DIN 5156			3002	G	G1/16" ÷ G2"	1 ÷ 6	6.1 ●	7 ÷ 10	E	59
DIN 5156	TiN		3012	G	G1/16" ÷ G2"	1 ÷ 6	6.1 ●	8 ÷ 12	E	59
DIN 5156			3502	G	G1/16" ÷ G2"	1; 2; 3	6.2 ●	4 ÷ 7	E	59
DIN 5156	TiN		3512	G	G1/16" ÷ G2"	1; 2; 3	6.2 ●	6 ÷ 8	E	59
DIN 5156			4052	G	G1/16" ÷ G11/2"	3; 4; 5; 6	6.2 ●	4 ÷ 7	E	60
DIN 5156	TiN		4062	G	G1/16" ÷ G11/2"	3; 4; 5; 6	6.2 ●	6 ÷ 8	E	60
~ DIN 371			1004	UNC	5-40 ÷ 3/8-16	1 ÷ 6	6.1 ●	7 ÷ 10	E	62
~ DIN 371	TiN		1014	UNC	5-40 ÷ 3/8-16	1 ÷ 6	6.1 ●	8 ÷ 12	E	62
~ DIN 376			3004	UNC	7/16-14 ÷ 11/8-7	1 ÷ 6	6.1 ●	7 ÷ 10	E	63

● doporučené užití / recommended use / optimal

● možno použít / possible use / geeignet



VOLBA ZÁVITNÍKU DLE OBRÁBĚNÉHO MATERIÁLU

TAP SELECTION ACCORDING TO MATERIAL GROUPS

GEWINDEBOHRERWAHL NACH WERKSTOFFGRUPPE

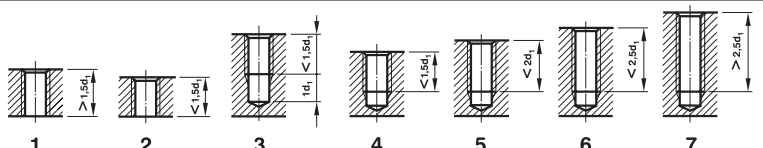
SKUPINA OBRÁBĚNÉHO MATERIÁLU 6 / MATERIAL GROUP 6 / WERKSTOFFGRUPPE 6

Litiny Cast iron Gusswerkstoffe	
---------------------------------------	--

Norma Standard Norm			Kat. č. Cat. No. Kat. Nr.	Závit Thread Gewinde	Rozsah Ø-Range Abmessungsbereich	Typ otvoru Hole type Lochform	Použití Application Anwendung	V_c m/min		Strana Page Seite
~ DIN 376	TiN		3014	UNC	7/16-14 ÷ 11/8-7	1 ÷ 6	6.1 ●	8 ÷ 12	E	63
~ DIN 371			1504	UNC	5-40 ÷ 3/8-16	1; 2; 3	6.2 ●	4 ÷ 7	E	62
~ DIN 371	TiN		1514	UNC	5-40 ÷ 3/8-16	1; 2; 3	6.2 ●	6 ÷ 8	E	62
~ DIN 376			3504	UNC	7/16-14 ÷ 11/8-7	1; 2; 3	6.2 ●	4 ÷ 7	E	63
~ DIN 376	TiN		3514	UNC	7/16-14 ÷ 11/8-7	1; 2; 3	6.2 ●	6 ÷ 8	E	63
~ DIN 371			2054	UNC	5-40 ÷ 3/8-16	3; 4; 5; 6	6.2 ●	4 ÷ 7	E	64
~ DIN 371	TiN		2064	UNC	5-40 ÷ 3/8-16	3; 4; 5; 6	6.2 ●	6 ÷ 8	E	64
~ DIN 376			4054	UNC	7/16-14 ÷ 1-7	3; 4; 5; 6	6.2 ●	4 ÷ 7	E	64
~ DIN 376	TiN		4064	UNC	7/16-14 ÷ 1-7	3; 4; 5; 6	6.2 ●	6 ÷ 8	E	64
~ DIN 374			3005	UNF	5-44 ÷ 11/8-12	1 ÷ 6	6.1 ●	7 ÷ 10	E	65
~ DIN 374	TiN		3015	UNF	5-44 ÷ 11/8-12	1 ÷ 6	6.1 ●	8 ÷ 12	E	65
~ DIN 374			3505	UNF	5-44 ÷ 11/8-12	1; 2; 3	6.2 ●	4 ÷ 7	E	65
~ DIN 374	TiN		3515	UNF	5-44 ÷ 11/8-12	1; 2; 3	6.2 ●	6 ÷ 8	E	65
~ DIN 374			4055	UNF	5-44 ÷ 1-12	3; 4; 5; 6	6.2 ●	4 ÷ 7	E	66
~ DIN 374	TiN		4065	UNF	5-44 ÷ 1-12	3; 4; 5; 6	6.2 ●	6 ÷ 8	E	66

● doporučené užití / recommended use / optimal







● možno použít / possible use / geeignet

VOLBA ZÁVITNÍKU DLE OBRÁBĚNÉHO MATERIÁLU

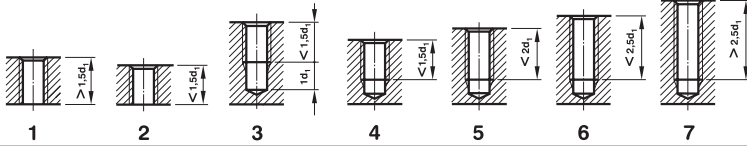
TAP SELECTION ACCORDING TO MATERIAL GROUPS

GEWINDEBOHRERWAHL NACH WERKSTOFFGRUPPE

SKUPINA OBRÁBĚNÉHO MATERIÁLU 7 / MATERIAL GROUP 7 / WERKSTOFFGRUPPE 7

Norma Standard Norm		Kat. č. Cat. No. Kat. Nr.	Závit Thread Gewinde	Rozsah Ø-Range Abmessungsbereich	Typ otvoru Hole type Lochform	Použití Application Anwendung	V_c m/min		Strana Page Seite		
Hliník měkký Unalloyed aluminium Reinaluminium											
DIN 371	ALS		1620	M	M3 ÷ M10	1; 2	7.1	<input checked="" type="radio"/>	15 ÷ 35	E	45
DIN 376	ALS		3620	M	M3 ÷ M36	1; 2	7.1	<input checked="" type="radio"/>	15 ÷ 35	E	45
DIN 371	ALS		2720	M	M3 ÷ M10	3; 4; 5	7.1	<input checked="" type="radio"/>	15 ÷ 35	E/O	45
DIN 376	ALS		4720	M	M3 ÷ M36	3; 4; 5	7.1	<input checked="" type="radio"/>	15 ÷ 35	E/O	45
DIN 2174	TiN		2910	M	M3 ÷ M12	1 ÷ 7	7.1	<input type="radio"/>	15 ÷ 35	0	68
DIN 2174	TiN		2960	M	M3 ÷ M12	1 ÷ 7	7.1	<input checked="" type="radio"/>	15 ÷ 35	0	68

● doporučené užití / recommended use / optimal ● možno použít / possible use / geeignet

VOLBA ZÁVITNÍKU DLE OBRÁBĚNÉHO MATERIÁLU

TAP SELECTION ACCORDING TO MATERIAL GROUPS

GEWINDEBOHRERWAHL NACH WERKSTOFFGRUPPE

SKUPINA OBRÁBĚNÉHO MATERIÁLU 8 / MATERIAL GROUP 8 / WERKSTOFFGRUPPE 8

Hliník legovaný Aluminium alloys Aluminiumlegierungen	
---	--

Norma Standard Norm		Kat. č. Cat. No. Kat. Nr.	Závit Thread Gewinde	Rozsah Ø-Range Abmessungsbereich	Typ otvoru Hole type Lochform	Použití Application Anwendung	V _c m/min		Strana Page Seite
DIN 371		1000	M	M3 ÷ M10	2	8.2 ●	12 ÷ 15	E	30
DIN 371	TiN	1010	M	M3 ÷ M10	2	8.2 ●	14 ÷ 20	E	30
DIN 376		3000	M	M3 ÷ M52	2	8.2 ●	12 ÷ 15	E	31
DIN 376	TiN	3010	M	M3 ÷ M52	2	8.2 ●	14 ÷ 20	E	31
DIN 371		1500	M	M3 ÷ M10	1;2	8.1 ● 8.2 ●	14 ÷ 20 12 ÷ 15	E	32
DIN 371	TiN	1510	M	M3 ÷ M10	1;2	8.1 ● 8.2 ●	15 ÷ 30 14 ÷ 20	E	32
DIN 371	OX	1540	M	M3 ÷ M10	1;2	8.1 ● 8.2 ●	14 ÷ 20 12 ÷ 15	E	32
DIN 371		1750	M	M3 ÷ M10	2	8.1 ● 8.2 ●	14 ÷ 20 12 ÷ 15	E	32
DIN 376		3500	M	M3 ÷ M36	1;2	8.1 ● 8.2 ●	14 ÷ 20 12 ÷ 15	E	33
DIN 376	TiN	3510	M	M3 ÷ M36	1;2	8.1 ● 8.2 ●	15 ÷ 30 14 ÷ 20	E	33
DIN 376	OX	3540	M	M3 ÷ M36	1;2	8.1 ● 8.2 ●	14 ÷ 20 12 ÷ 15	E	33
DIN 371		2050	M	M3 ÷ M10	3;4;5	8.1 ●	14 ÷ 20	E	34
DIN 371	TiN	2060	M	M3 ÷ M10	3;4;5	8.1 ● 8.2 ●	15 ÷ 30 14 ÷ 20	E	34
DIN 371	OX	2090	M	M3 ÷ M10	3;4;5	8.1 ● 8.2 ●	14 ÷ 20 12 ÷ 15	E	34
DIN 376		4050	M	M3 ÷ M36	3;4;5	8.1 ●	14 ÷ 20	E	35
DIN 376	TiN	4060	M	M3 ÷ M36	3;4;5	8.1 ● 8.2 ●	15 ÷ 30 14 ÷ 20	E	35
DIN 376	OX	4090	M	M3 ÷ M36	3;4;5	8.1 ● 8.2 ●	14 ÷ 20 12 ÷ 15	E	35
DIN 371	TiN	2360	M	M3 ÷ M10	3;4;5	8.1 ●	14 ÷ 20	E	36
DIN 371	OX	2390	M	M3 ÷ M10	3;4;5	8.1 ●	14 ÷ 20	E	36
DIN 376	TiN	4360	M	M3 ÷ M36	3;4;5	8.1 ●	14 ÷ 20	E	37
DIN 376	OX	4390	M	M3 ÷ M36	3;4;5	8.1 ●	14 ÷ 20	E	37
DIN 371	ALS	1570	M	M3 ÷ M10	1;2	8.2 ●	15 ÷ 30	E	45
DIN 371	OX	1590	M	M3 ÷ M10	1;2	8.2 ●	12 ÷ 15	E	42
DIN 376	ALS	3570	M	M3 ÷ M36	1;2	8.2 ●	15 ÷ 30	E	45
DIN 376	OX	3590	M	M3 ÷ M36	1;2	8.2 ●	12 ÷ 15	E	43
DIN 371	ALS	2670	M	M3 ÷ M10	3;4;5;6	8.2 ●	12 ÷ 20	E	45
DIN 376	ALS	4670	M	M3 ÷ M36	3;4;5;6	8.2 ●	12 ÷ 20	E	45
DIN 371	TiCN	1080	M	M3 ÷ M10	2;3	8.2 ●	12 ÷ 20	E	46

● doporučené užití / recommended use / optimal

● možno použít / possible use / geeignet

VOLBA ZÁVITNÍKU DLE OBRÁBĚNÉHO MATERIÁLU

TAP SELECTION ACCORDING TO MATERIAL GROUPS

GEWINDEBOHRERWAHL NACH WERKSTOFFGRUPPE

SKUPINA OBRÁBĚNÉHO MATERIÁLU 8 / MATERIAL GROUP 8 / WERKSTOFFGRUPPE 8

Hliník legovaný
Aluminium alloys
Aluminiumlegierungen

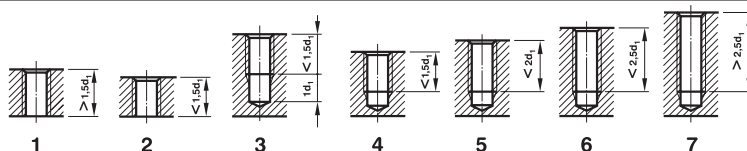

Norma Standard Norm		Kat. č. Cat. No. Kat. Nr.	Závit Thread Gewinde	Rozsah Ø-Range Abmessungsbereich	Typ otvoru Hole type Lochform	Použití Application Anwendung	V _c m/min		Strana Page Seite
DIN 371	TiCN	1080 IKZ	M	M5 ÷ M10	2; 3	8.2 ●	12 ÷ 20	E	46
DIN 371	TiCN	1130	M	M3 ÷ M10	2; 3	8.2 ●	12 ÷ 20	E	46
DIN 371	TiCN	1130 IKZ	M	M5 ÷ M10	2; 3	8.2 ●	12 ÷ 20	E	46
DIN 376	TiCN	3080	M	M3 ÷ M52	2; 3	8.2 ●	12 ÷ 20	E	47
DIN 376	TiCN	3080 IKZ	M	M5 ÷ M52	2; 3	8.2 ●	12 ÷ 20	E	47
DIN 376	TiCN	3130	M	M3 ÷ M52	2; 3	8.2 ●	12 ÷ 20	E	47
DIN 376	TiCN	3130 IKZ	M	M5 ÷ M52	2; 3	8.2 ●	12 ÷ 20	E	47
DIN 371	TiN	1710	M	M3 ÷ M10	1; 2	8.1 ● 8.2 ●	12 ÷ 20	E	48
DIN 376	TiN	3710	M	M12 ÷ M20	1; 2	8.1 ● 8.2 ●	12 ÷ 20	E	48
DIN 371	TiN	2210	M	M3 ÷ M10	3; 4; 5	8.1 ● 8.2 ●	12 ÷ 20	E	48
DIN 376	TiN	4210	M	M12 ÷ M20	3; 4; 5	8.1 ● 8.2 ●	12 ÷ 20	E	48
DIN 352		0550	M	M3 ÷ M12	1; 2	8.1 ● 8.2 ●	14 ÷ 20 12 ÷ 15	E	67
DIN 352		0600	M	M3 ÷ M12	3; 4; 5	8.1 ●	14 ÷ 20	E	67
DIN 2174	TiN	2910	M	M3 ÷ M12	1 ÷ 7	8.1 ●	15 ÷ 30	E/O	68
DIN 2174	TiN	2960	M	M3 ÷ M12	1 ÷ 7	8.1 ●	15 ÷ 30	E/O	68
DIN 374		3000	MF	M3 ÷ M52	2	8.2 ●	12 ÷ 15	E	49
DIN 374	TiN	3010	MF	M3 ÷ M52	2	8.2 ●	14 ÷ 20	E	49
DIN 374		3500	MF	M3 ÷ M36	1; 2	8.1 ● 8.2 ●	14 ÷ 20 12 ÷ 15	E	49
DIN 374	TiN	3510	MF	M3 ÷ M36	1; 2	8.1 ● 8.2 ●	15 ÷ 30 14 ÷ 20	E	49
DIN 374	OX	3540	MF	M3 ÷ M36	1; 2	8.1 ● 8.2 ●	14 ÷ 20 12 ÷ 15	E	49
DIN 374		4050	MF	M3 ÷ M36	3; 4; 5	8.1 ●	14 ÷ 20	E	51
DIN 374	TiN	4060	MF	M3 ÷ M36	3; 4; 5	8.1 ● 8.2 ●	15 ÷ 30 14 ÷ 20	E	51
DIN 374	OX	4090	MF	M3 ÷ M36	3; 4; 5	8.1; 8.2 ●	14 ÷ 20 12 ÷ 15	E	51
DIN 374	TiCN	3580	MF	M3 ÷ M36	1; 2	8.2 ●	15 ÷ 30	E	55
DIN 374	OX	3590	MF	M3 ÷ M36	1; 2	8.2 ●	12 ÷ 15	E	55
DIN 374	TiCN	4680	MF	M3 ÷ M36	3; 4; 5; 6	8.2 ●	12 ÷ 20	E	55
DIN 374	TiCN	3080	MF	M3 ÷ M52	1; 2	8.2 ●	12 ÷ 20	E	57
DIN 374	TiCN	3080 IKZ	MF	M5 ÷ M52	1; 2	8.2 ●	12 ÷ 20	E	57

● doporučené užití / recommended use / optimal

● možno použít / possible use / geeignet

VOLBA ZÁVITNÍKU DLE OBRÁBĚNÉHO MATERIÁLU

TAP SELECTION ACCORDING TO MATERIAL GROUPS

GEWINDEBOHRERWAHL NACH WERKSTOFFGRUPPE

SKUPINA OBRÁBĚNÉHO MATERIÁLU 8 / MATERIAL GROUP 8 / WERKSTOFFGRUPPE 8

Hliník legovaný Aluminium alloys Aluminiumlegierungen	
---	--

Norma Standard Norm		Kat. č. Cat. No. Kat. Nr.	Závít Thread Gewinde	Rozsah Ø-Range Abmessungsbereich	Typ otvoru Hole type Lochform	Použití Application Anwendung	V _c m/min		Strana Page Seite		
DIN 374	TiCN		3130	MF	M3 ÷ M52	1;2	8.2	●	12 ÷ 20	E	57
DIN 374	TiCN		3130 IKZ	MF	M5 ÷ M52	1;2	8.2	●	12 ÷ 20	E	57
DIN 5156			3002	G	G1/16" ÷ G2"	2	8.2	●	12 ÷ 15	E	59
DIN 5156	TiN		3012	G	G1/16" ÷ G2"	2	8.2	●	14 ÷ 20	E	59
DIN 5156			3502	G	G1/16" ÷ G2"	1;2	8.1 8.2	● ●	14 ÷ 20 12 ÷ 15	E	59
DIN 5156	TiN		3512	G	G1/16" ÷ G2"	1;2	8.1 8.2	● ●	15 ÷ 30 14 ÷ 20	E	59
DIN 5156			4052	G	G1/16" ÷ G11/2"	3;4;5	8.1	●	14 ÷ 20	E	60
DIN 5156	TiN		4062	G	G1/16" ÷ G11/2"	3;4;5	8.1 8.2	● ●	15 ÷ 30 14 ÷ 20	E	60
~ DIN 371			1004	UNC	5-40 ÷ 3/8-16	2	8.2	●	12 ÷ 15	E	62
~ DIN 371	TiN		1014	UNC	5-40 ÷ 3/8-16	2	8.2	●	14 ÷ 20	E	62
~ DIN 376			3004	UNC	7/16-14 ÷ 11/8-7	2	8.2	●	12 ÷ 15	E	63
~ DIN 376	TiN		3014	UNC	7/16-14 ÷ 11/8-7	2	8.2	●	14 ÷ 20	E	63
~ DIN 371			1504	UNC	5-40 ÷ 3/8-16	1;2	8.1 8.2	● ●	14 ÷ 20 12 ÷ 15	E	62
~ DIN 371	TiN		1514	UNC	5-40 ÷ 3/8-16	1;2	8.1 8.2	● ●	15 ÷ 30 14 ÷ 20	E	62
~ DIN 376			3504	UNC	7/16-14 ÷ 11/8-7	1;2	8.1 8.2	● ●	14 ÷ 20 12 ÷ 15	E	63
~ DIN 376	TiN		3514	UNC	7/16-14 ÷ 11/8-7	1;2	8.1 8.2	● ●	15 ÷ 30 14 ÷ 20	E	63
~ DIN 371			2054	UNC	5-40 ÷ 3/8-16	3;4;5	8.1	●	14 ÷ 20	E	64
~ DIN 371	TiN		2064	UNC	5-40 ÷ 3/8-16	3;4;5	8.1 8.2	● ●	15 ÷ 30 14 ÷ 20	E	64
~ DIN 376			4054	UNC	7/16-14 ÷ 1-7	3;4;5	8.1	●	14 ÷ 20	E	64
~ DIN 376	TiN		4064	UNC	7/16-14 ÷ 1-7	3;4;5	8.1 8.2	● ●	15 ÷ 30 14 ÷ 20	E	64
~ DIN 374			3005	UNF	5-44 ÷ 11/8-12	2	8.2	●	12 ÷ 15	E	65
~ DIN 374	TiN		3015	UNF	5-44 ÷ 11/8-12	2	8.2	●	14 ÷ 20	E	65
~ DIN 374			3505	UNF	5-44 ÷ 11/8-12	1;2	8.1 8.2	● ●	14 ÷ 20 12 ÷ 15	E	65
~ DIN 374	TiN		3515	UNF	5-44 ÷ 11/8-12	1;2	8.1 8.2	● ●	15 ÷ 30 14 ÷ 20	E	65
~ DIN 374			4055	UNF	5-44 ÷ 1-12	3;4;5	8.1	●	14 ÷ 20	E	66
~ DIN 374	TiN		4065	UNF	5-44 ÷ 1-12	3;4;5	8.1 8.2	● ●	15 ÷ 30 14 ÷ 20	E	66

● doporučené užití / recommended use / optimal







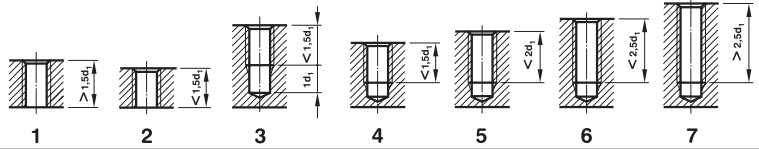

● možno použít / possible use / geeignet

VOLBA ZÁVITNÍKU DLE OBRÁBĚNÉHO MATERIÁLU TAP SELECTION ACCORDING TO MATERIAL GROUPS GEWINDEBOHRERWAHL NACH WERKSTOFFGRUPPE

SKUPINA OBRÁBĚNÉHO MATERIÁLU 9 / MATERIAL GROUP 9 / WERKSTOFFGRUPPE 9

Měď čistá
Unalloyed copper
Reinkupfer



Norma Standard Norm		Kat. Č. Cat. No. Kat. Nr.	Závit Thread Gewinde	Rozsah Ø-Range Abmessungsbereich	Typ otvoru Hole type Lochform	Použití Application Anwendung	V _c m/min		Strana Page Seite	
DIN 371	TiN		2360	M	M3 ÷ M10	3; 4; 5	9.1 ●	5 ÷ 8	0	36
DIN 376	TiN		4360	M	M3 ÷ M36	3; 4; 5	9.1 ●	5 ÷ 8	0	37
DIN 371	TiN		1660	M	M3 ÷ M10	1; 2	9.1 ●	8 ÷ 12	0	38
DIN 371	HL		1870	M	M3 ÷ M10	1; 2	9.1 ●	10 ÷ 15	0	38
DIN 371	HL		1870 IKZN	M	M6 ÷ M10	1; 2	9.1 ●	10 ÷ 15	0	38
DIN 376	TiN		3660	M	M3 ÷ M10	1; 2	9.1 ●	8 ÷ 12	0	39
DIN 376	HL		3870	M	M12	1; 2	9.1 ●	10 ÷ 15	0	39
DIN 376	HL		3870 IKZN	M	M12	1; 2	9.1 ●	10 ÷ 15	0	39
DIN 371	TiN		2260	M	M3 ÷ M10	3; 4; 5	9.1 ●	8 ÷ 12	0	40
DIN 371	HL		2320	M	M3 ÷ M10	3; 4; 5	9.1 ●	10 ÷ 15	0	40
DIN 371	HL		2320 IKZ	M	M5 ÷ M10	3; 4; 5	9.1 ●	10 ÷ 15	0	40
DIN 376	TiN		4260	M	M3 ÷ M36	3; 4; 5	9.1 ●	8 ÷ 12	0	41
DIN 376	HL		4320	M	M12	3; 4; 5	9.1 ●	10 ÷ 15	0	41
DIN 376	HL		4320 IKZ	M	M12	3; 4; 5	9.1 ●	10 ÷ 15	0	41
DIN 2174	TiN		2960	M	M3 ÷ M12	1 ÷ 7	9.1 ●	15 ÷ 30	0	68
DIN 374	TiN		3660	MF	M3 ÷ M36	1; 2	9.1 ●	8 ÷ 12	0	53
DIN 374	TiN		4260	MF	M3 ÷ M36	3; 4; 5	9.1 ●	8 ÷ 12	0	53
DIN 5156	TiN		3662	G	G1/16" ÷ G1/2"	1; 2	9.1 ●	8 ÷ 12	0	61
DIN 5156	TiN		4262	G	G1/16" ÷ G1/2"	3; 4; 5	9.1 ●	8 ÷ 12	0	61

● doporučené užití / recommended use / optimal

● možno použít / possible use / geeignet

VOLBA ZÁVITNÍKU DLE OBRÁBĚNÉHO MATERIÁLU

TAP SELECTION ACCORDING TO MATERIAL GROUPS

GEWINDEBOHRERWAHL NACH WERKSTOFFGRUPPE

SKUPINA OBRÁBĚNÉHO MATERIÁLU 10 / MATERIAL GROUP 10 / WERKSTOFFGRUPPE 10

Slitiny mědi Copper alloys Kupferlegierungen	
--	--

Norma Standard Norm		Kat. č. Cat. No. Kat. Nr.	Závit Thread Gewinde	Rozsah Ø-Range Abmessungsbereich	Typ otvoru Hole type Lochform	Použití Application Anwendung	V_c m/min		Strana Page Seite
DIN 371		1000	M	M3 ÷ M10	2; 3	10.1 ●	10 ÷ 15	O/E	30
DIN 371	TiN	1010	M	M3 ÷ M10	2; 3	10.1 ●	15 ÷ 25	O/E	30
DIN 376		3000	M	M3 ÷ M52	2; 3	10.1 ●	10 ÷ 15	O/E	31
DIN 376	TiN	3010	M	M3 ÷ M52	2; 3	10.1 ●	15 ÷ 25	O/E	31
DIN 371		1500	M	M3 ÷ M10	1; 2	10.1 ●	12 ÷ 20	O/E	32
DIN 371	TiN	1510	M	M3 ÷ M10	1; 2	10.1 ●	15 ÷ 25	O/E	32
DIN 376		3500	M	M3 ÷ M36	1; 2	10.1 ●	12 ÷ 20	O/E	33
DIN 376	TiN	3510	M	M3 ÷ M36	1; 2	10.1 ●	15 ÷ 25	O/E	33
DIN 371		2050	M	M3 ÷ M10	3; 4; 5	10.2 ●	6 ÷ 10	0	34
DIN 371	TiN	2060	M	M3 ÷ M10	3; 4; 5	10.2 ●	10 ÷ 15	0	34
DIN 376		4050	M	M3 ÷ M36	3; 4; 5	10.2 ●	6 ÷ 10	0	35
DIN 376	TiN	4060	M	M3 ÷ M36	3; 4; 5	10.2 ●	10 ÷ 15	0	35
DIN 371		2400	M	M3 ÷ M10	3; 4; 5; 6	10.1 ●	10 ÷ 15	O/E	36
DIN 371	TiN	2410	M	M3 ÷ M10	3; 4; 5; 6	10.1 ●	12 ÷ 20	O/E	36
DIN 376		4400	M	M3 ÷ M36	3; 4; 5; 6	10.1 ●	10 ÷ 15	O/E	37
DIN 376	TiN	4410	M	M3 ÷ M36	3; 4; 5; 6	10.1 ●	12 ÷ 20	O/E	37
DIN 371	TiN	1660	M	M3 ÷ M10	1; 2	10.2 ●	10 ÷ 15	0	38
DIN 371	HL	1870	M	M6 ÷ M10	1; 2	10.2 ●	12 ÷ 20	0	38
DIN 371	HL	1870 IKZN	M	M6 ÷ M10	1; 2	10.2 ●	12 ÷ 20	0	38
DIN 376	TiN	3660	M	M3 ÷ M36	1; 2	10.2 ●	10 ÷ 15	0	39
DIN 376	HL	3870	M	M12	1; 2	10.2 ●	12 ÷ 20	0	39
DIN 376	HL	3870 IKZN	M	M12	1; 2	10.2 ●	12 ÷ 20	0	39
DIN 371	TiN	2260	M	M3 ÷ M10	3; 4; 5	10.2 ●	10 ÷ 15	0	40
DIN 371	HL	2320	M	M3 ÷ M10	3; 4; 5	10.2 ●	12 ÷ 20	0	40
DIN 371	HL	2320 IKZ	M	M5 ÷ M10	3; 4; 5	10.2 ●	12 ÷ 20	0	40
DIN 376	TiN	4260	M	M3 ÷ M36	3; 4; 5	10.2 ●	10 ÷ 15	0	41
DIN 376	HL	4320	M	M12	3; 4; 5	10.2 ●	12 ÷ 20	0	41
DIN 376	HL	4320 IKZ	M	M12	3; 4; 5	10.2 ●	12 ÷ 20	0	41

● doporučené užití / recommended use / optimal

● možno použít / possible use / geeignet

VOLBA ZÁVITNÍKU DLE OBRÁBĚNÉHO MATERIÁLU

TAP SELECTION ACCORDING TO MATERIAL GROUPS

GEWINDEBOHRERWAHL NACH WERKSTOFFGRUPPE

SKUPINA OBRÁBĚNÉHO MATERIÁLU 10 / MATERIAL GROUP 10 / WERKSTOFFGRUPPE 10

Slitiny mědi Copper alloys Kupferlegierungen	
--	--

Norma Standard Norm		Kat. č. Cat. No. Kat. Nr.	Závit Thread Gewinde	Rozsah Ø-Range Abmessungsbereich	Typ otvoru Hole type Lochform	Použití Application Anwendung	V_c m/min		Strana Page Seite		
DIN 371	TiN		1710	M	M3 ÷ M10	1; 2	10.2	●	12 ÷ 20	0	48
DIN 376	TiN		3710	M	M12 ÷ M20	1; 2	10.2	●	12 ÷ 20	0	48
DIN 371	TiN		2210	M	M3 ÷ M10	3; 4; 5	10.2	●	12 ÷ 20	0	48
DIN 376	TiN		4210	M	M12 ÷ M20	3; 4; 5	10.2	●	12 ÷ 20	0	48
DIN 352			0550	M	M3 ÷ M12	1; 2	10.1	●	12 ÷ 20	0/E	67
DIN 352			0600	M	M3 ÷ M12	3; 4; 5	10.2	●	6 ÷ 10	0	67
DIN 352			0650	M	M3 ÷ M12	3; 4; 5; 6	10.1	●	10 ÷ 15	0/E	67
DIN 374			3000	MF	M3 ÷ M52	2; 3	10.1	●	10 ÷ 15	0/E	49
DIN 374	TiN		3010	MF	M3 ÷ M52	2; 3	10.1	●	15 ÷ 25	0/E	49
DIN 374			3500	MF	M3 ÷ M36	1; 2	10.1	●	12 ÷ 20	0/E	49
DIN 374	TiN		3510	MF	M3 ÷ M36	1; 2	10.1	●	15 ÷ 25	0/E	49
DIN 374			4050	MF	M3 ÷ M36	3; 4; 5	10.2	●	6 ÷ 10	0	51
DIN 374	TiN		4060	MF	M3 ÷ M36	3; 4; 5	10.2	●	10 ÷ 15	0	51
DIN 374	TiN		3660	MF	M3 ÷ M36	1; 2	10.2	●	10 ÷ 15	0	53
DIN 374	TiN		4260	MF	M3 ÷ M36	3; 4; 5	10.2	●	10 ÷ 15	0	53
DIN 5156			3002	G	G1/16" ÷ G2"	2; 3	10.1	●	10 ÷ 15	0/E	59
DIN 5156	TiN		3012	G	G1/16" ÷ G2"	2; 3	10.1	●	15 ÷ 25	0/E	59
DIN 5156			3502	G	G1/16" ÷ G2"	1; 2	10.1	●	12 ÷ 20	0/E	59
DIN 5156	TiN		3512	G	G1/16" ÷ G2"	1; 2	10.1	●	15 ÷ 25	0/E	59
DIN 5156			4052	G	G1/16" ÷ G11/2"	3; 4; 5	10.2	●	6 ÷ 10	0	60
DIN 5156	TiN		4062	G	G1/16" ÷ G11/2"	3; 4; 5	10.2	●	10 ÷ 15	0	60
DIN 5156	TiN		3662	G	G1/16" ÷ G11/2"	1; 2	10.2	●	10 ÷ 15	0	61
DIN 5156	TiN		4262	G	G1/16" ÷ G11/2"	3; 4; 5	10.2	●	10 ÷ 15	0	61
~ DIN 371			1004	UNC	5-40 ÷ 3/8-16	2; 3	10.1	●	10 ÷ 15	0/E	62
~ DIN 371	TiN		1014	UNC	5-40 ÷ 3/8-16	2; 3	10.1	●	15 ÷ 25	0/E	62
~ DIN 376			3004	UNC	7/16-14 ÷ 11/8-7	2; 3	10.1	●	10 ÷ 15	0/E	63
~ DIN 376	TiN		3014	UNC	7/16-14 ÷ 11/8-7	2; 3	10.1	●	15 ÷ 25	0/E	63
~ DIN 371			1504	UNC	5-40 ÷ 3/8-16	1; 2	10.1	●	12 ÷ 20	0/E	62

● doporučené užití / recommended use / optimal

● možno použít / possible use / geeignet

VOLBA ZÁVITNÍKU DLE OBRÁBĚNÉHO MATERIÁLU TAP SELECTION ACCORDING TO MATERIAL GROUPS GEWINDEBOHRERWAHL NACH WERKSTOFFGRUPPE

SKUPINA OBRÁBĚNÉHO MATERIÁLU **10** / MATERIAL GROUP **10** / WERKSTOFFGRUPPE **10**

Slitiny mědi Copper alloys Kupferlegierungen							
--	--	--	--	--	--	--	--

Norma Standard Norm			Kat. č. Cat. No. Kat. Nr.	Závit Thread Gewinde	Rozsah Ø-Range Abmessungsbereich	Typ otvoru Hole type Lochform	Použití Application Anwendung	V_c m/min		Strana Page Seite
~ DIN 371	TiN		1514	UNC	5-40 ÷ 3/8-16	1;2	10.1 ●	15 ÷ 25	0/E	62
~ DIN 376			3504	UNC	7/16-14 ÷ 1/8-7	1;2	10.1 ●	12 ÷ 20	0/E	63
~ DIN 376	TiN		3514	UNC	7/16-14 ÷ 1/8-7	1;2	10.1 ●	15 ÷ 25	0/E	63
~ DIN 371			2054	UNC	5-40 ÷ 3/8-16	3;4;5	10.2 ●	6 ÷ 10	0	64
~ DIN 371	TiN		2064	UNC	5-40 ÷ 3/8-16	3;4;5	10.2 ●	10 ÷ 15	0	64
~ DIN 376			4054	UNC	7/16-14 ÷ 1-7	3;4;5	10.2 ●	6 ÷ 10	0	64
~ DIN 376	TiN		4064	UNC	7/16-14 ÷ 1-7	3;4;5	10.2 ●	10 ÷ 15	0	64
~ DIN 374			3005	UNF	5-44 ÷ 1/8-12	2;3	10.1 ●	10 ÷ 15	0/E	65
~ DIN 374	TiN		3015	UNF	5-44 ÷ 1/8-12	2;3	10.1 ●	15 ÷ 25	0/E	65
~ DIN 374			3505	UNF	5-44 ÷ 1/8-12	1;2	10.1 ●	12 ÷ 20	0/E	65
~ DIN 374	TiN		3515	UNF	5-44 ÷ 1/8-12	1;2	10.1 ●	15 ÷ 25	0/E	65
~ DIN 374			4055	UNF	5-44 ÷ 1-12	3;4;5	10.2 ●	6 ÷ 10	0	66
~ DIN 374	TiN		4065	UNF	5-44 ÷ 1-12	3;4;5	10.2 ●	10 ÷ 15	0	66

● doporučené užití / recommended use / optimal

● možno použít / possible use / geeignet

STROJNÍ ZÁVITNÍKY

Machine taps / Maschinengewindebohrer

narex
zdánice



Skupina obráběného materiálu
Material group / Werkstoffgruppe

10.1; 1.1; 2.1; 6.1; 8.2



1000

8.2; 10.1; 1.1; 2.1; 6.1



1010

Katalogové číslo / Cat. No. / Kat. Nr.								1000	1010
<p>z = počet drážek / z = number of flutes / z = Nutenzahl</p>									TiN
d ₁	P	l ₁	l ₂	d ₂	a	z	Ø mm		
M 3	0,5	56	9	3,5	2,7	3	2,5	■	■
M 3,5	0,6	56	11	4	3	3	2,9	■	■
M 4	0,7	63	12	4,5	3,4	3	3,3	■	■
M 4,5	0,75	70	13	6	4,9	3	3,7		
M 5	0,8	70	13	6	4,9	3	4,2	■	■
M 6	1	80	15	6	4,9	3	5	■	■
M 7	1	80	15	7	5,5	3	6		
M 8	1,25	90	18	8	6,2	3	6,8	■	■
M 9	1,25	90	18	9	7	3	7,8		
M 10	1,5	100	20	10	8	3	8,5	■	■

■ dodáváme standardně / standard supplies / Standardlieferbar

X.X Doporučené užití / Recommended use / Optimal
X.X Možno použít / Possible use / Geeignet

STROJNÍ ZÁVITNÍKY

Machine taps / Maschinengewindebohrer

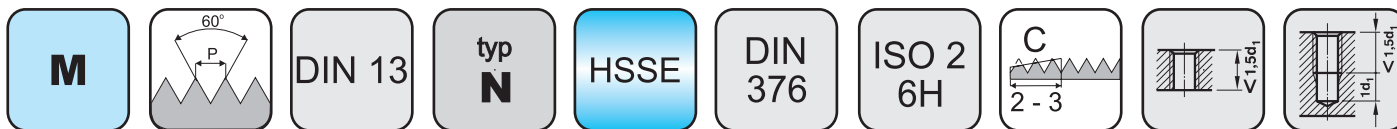

Skupina obráběného materiálu
Material group / Werkstoffgruppe

10.1; 1.1; 2.1; 6.1; 8.2



3000

8.2; 10.1; 1.1; 2.1; 6.1



3010

Katalogové číslo / Cat. No. / Kat. Nr.								3000	3010
								TiN	
d ₁	P	l ₁	l ₂	d ₂	a	z	Ø mm		
M 3	0,5	56	9	2,2	-	3	2,5	■	■
M 3,5	0,6	56	11	2,5	2,1	3	2,9		
M 4	0,7	63	12	2,8	2,1	3	3,3	■	■
M 4,5	0,75	70	13	3,5	2,7	3	3,7		
M 5	0,8	70	13	3,5	2,7	3	4,2	■	■
M 6	1	80	15	4,5	3,4	3	5	■	■
M 7	1	80	15	5,5	4,3	3	6	■	■
M 8	1,25	90	18	6	4,9	3	6,8	■	■
M 9	1,25	90	18	7	5,5	3	7,8		
M 10	1,5	100	20	7	5,5	3	8,5	■	■
M 11	1,5	100	20	8	6,2	3	9,5		
M 12	1,75	110	23	9	7	3	10,2	■	■
M 14	2	110	25	11	9	3	12	■	■
M 16	2	110	25	12	9	3	14	■	■
M 18	2,5	125	30	14	11	3	15,5	■	■
M 20	2,5	140	30	16	12	3	17,5	■	■
M 22	2,5	140	30	18	14,5	3	19,5	■	■
M 24	3	160	36	18	14,5	4	21	■	■
M 27	3	160	36	20	16	4	24	■	■
M 30	3,5	180	40	22	18	4	26,5	■	■
M 33	3,5	180	42	25	20	4	29,5	■	■
M 36	4	200	50	28	22	4	32	■	■
M 39	4	200	50	32	24	4	35	■	■
M 42	4,5	200	56	32	24	4	37,5	■	■
M 45	4,5	200	56	36	29	4	40,5	■	■
M 48	5	250	63	36	29	4	43	■	■
M 52	5	250	63	40	32	4	47	■	■

■ dodáváme standardně / standard supplies / Standardlieferbar

X.X Doporučené užití / Recommended use / Optimal

X.X Možno použít / Possible use / Geeignet



Skupina obráběného materiálu
Material group / Werkstoffgruppe

1.2; 2.2; 8.1; 1.1; 2.1; 2.3; 6.2; 8.2; 10.1



1500

1.1; 1.2; 2.1; 2.2; 2.3; 6.2; 8.1; 8.2; 10.1



1510

1.2; 2.2; 8.1; 11.1; 2.3; 8.2



1540

1.1; 1.2; 2.1; 2.2; 2.3; 8.1; 8.2



1750

Katalogové číslo / Cat. No. / Kat. Nr.								1500	1500	1510	1540	1750
								<div style="display: flex; justify-content: space-around;"> <div style="border: 1px solid black; padding: 2px;">TiN</div> <div style="border: 1px solid black; padding: 2px;">OX</div> </div>				
ISO 3 6G												
d ₁	P	l ₁	l ₂	d ₂	a	z	Ø mm					
M 2	0,4	45	8	2,8	2,1	3	1,6	■		■	■	
M 2,5	0,45	50	9	2,8	2,1	3	2,05	■		■	■	
M 3	0,5	56	9	3,5	2,7	3	2,5	■	■	■	■	■
M 3,5	0,6	56	11	4	3	3	2,9	■		■	■	
M 4	0,7	63	12	4,5	3,4	3	3,3	■		■	■	■
M 4,5	0,75	70	13	6	4,9	3	3,7	■		■	■	
M 5	0,8	70	13	6	4,9	3	4,2	■		■	■	■
M 6	1	80	15	6	4,9	3	5	■	■	■	■	■
M 7	1	80	15	7	5,5	3	6	■		■	■	
M 8	1,25	90	18	8	6,2	3	6,8	■	■	■	■	■
M 9	1,25	90	18	9	7	3	7,8	■		■	■	
M 10	1,5	100	20	10	8	3	8,5	■	■	■	■	■

■ dodáváme standardně / standard supplies / Standardlieferbar

X.X Doporučené užití / Recommended use / Optimal
X.X Možno použít / Possible use / Geeignet

STROJNÍ ZÁVITNÍKY

Machine taps / Maschinengewindebohrer



Skupina obráběného materiálu
Material group / Werkstoffgruppe

1.2; 2.2; 8.1; 1.1; 2.1; 2.3; 6.2; 8.2; 10.1



3500

1.1; 1.2; 2.1; 2.2; 2.3; 6.2; 8.1; 8.2; 10.1



3510

1.2; 2.2; 8.1; 11.1; 2.3; 8.2



3540

Katalogové číslo / Cat. No. / Kat. Nr.								3500	3500	3510	3540
										TiN	OX
								ISO 3 6G			
d ₁	P	l ₁	l ₂	d ₂	a	z	Ø mm				
M 3	0,5	56	9	2,2	-	3	2,5	■		■	■
M 3,5	0,6	56	11	2,5	2,1	3	2,9				
M 4	0,7	63	12	2,8	2,1	3	3,3	■		■	■
M 4,5	0,75	70	13	3,5	2,7	3	3,7				
M 5	0,8	70	13	3,5	2,7	3	4,2	■		■	■
M 6	1	80	15	4,5	3,4	3	5	■		■	■
M 7	1	80	15	5,5	4,3	3	6	■		■	■
M 8	1,25	90	18	6	4,9	3	6,8	■		■	■
M 9	1,25	90	18	7	5,5	3	7,8				
M 10	1,5	100	20	7	5,5	3	8,5	■		■	■
M 11	1,5	100	20	8	6,2	3	9,5				
M 12	1,75	110	23	9	7	3	10,2	■	■	■	■
M 14	2	110	25	11	9	3	12	■	■	■	■
M 16	2	110	25	12	9	3	14	■	■	■	■
M 18	2,5	125	30	14	11	3	15,5	■	■	■	■
M 20	2,5	140	30	16	12	3	17,5	■	■	■	■
M 22	2,5	140	30	18	14,5	3	19,5	■	■	■	■
M 24	3	160	36	18	14,5	4	21	■	■	■	■
M 27	3	160	36	20	16	4	24	■	■	■	■
M 30	3,5	180	40	22	18	4	26,5	■	■	■	■
M 33	3,5	180	42	25	20	4	29,5	■	■	■	■
M 36	4	200	50	28	22	4	32	■	■	■	■

■ dodáváme standardně / standard supplies / Standardlieferbar

X.X Doporučené užití / Recommended use / Optimal

X.X Možno použít / Possible use / Geeignet

STROJNÍ ZÁVITNÍKY

Machine taps / Maschinengewindebohrer



Skupina obráběného materiálu
Material group / Werkstoffgruppe

2.2; 2.3; 8.1; 6.2; 10.2



2050

2.2; 2.3; 8.1; 6.2; 8.2; 10.2



2060

11.1; 2.2; 2.3; 8.1; 8.2



2090

Katalogové číslo / Cat. No. / Kat. Nr.								2050	2050	2060	2090
										TiN	OX
								ISO 3 6G			
d ₁	P	l ₁	l ₂	d ₂	a	z	Ø mm				
M 2	0,4	45	6	2,8	2,1	3	1,6	■		■	■
M 2,5	0,45	50	7,5	2,8	2,1	3	2,05	■		■	■
M 3	0,5	56	5	3,5	2,7	3	2,5	■	■	■	■
M 3,5	0,6	56	6	4	3	3	2,9	■		■	■
M 4	0,7	63	7	4,5	3,4	3	3,3	■	■	■	■
M 4,5	0,75	70	8	6	4,9	3	3,7	■		■	■
M 5	0,8	70	8	6	4,9	3	4,2	■	■	■	■
M 6	1	80	10	6	4,9	3	5	■	■	■	■
M 7	1	80	10	7	5,5	3	6	■		■	■
M 8	1,25	90	13	8	6,2	3	6,8	■	■	■	■
M 9	1,25	90	13	9	7	3	7,8	■		■	■
M 10	1,5	100	15	10	8	3	8,5	■	■	■	■

■ dodáváme standardně / standard supplies / Standardlieferbar

X.X Doporučené užití / Recommended use / Optimal
X.X Možno použít / Possible use / Geeignet

STROJNÍ ZÁVITNÍKY

Machine taps / Maschinengewindebohrer



Skupina obráběného materiálu
Material group / Werkstoffgruppe

2.2; 2.3; 8.1; 6.2; 10.2



4050

2.2; 2.3; 8.1; 6.2; 8.2; 10.2



4060

11.1; 2.2; 2.3; 8.1; 8.2



4090

Katalogové číslo / Cat. No. / Kat. Nr.								4050	4050	4060	4090
								<div style="display: flex; justify-content: space-around;"> <div style="border: 1px solid black; padding: 2px;">TiN</div> <div style="border: 1px solid black; padding: 2px;">OX</div> </div>			
ISO 3 6G											
d ₁	P	l ₁	l ₂	d ₂	a	z	Ø mm				
M 3	0,5	56	5	2,2	-	3	2,5	■		■	
M 3,5	0,6	56	6	2,5	2,1	3	2,9	■			■
M 4	0,7	63	7	2,8	2,1	3	3,3	■		■	■
M 4,5	0,75	70	8	3,5	2,7	3	3,7	■			■
M 5	0,8	70	8	3,5	2,7	3	4,2	■		■	■
M 6	1	80	10	4,5	3,4	3	5	■		■	■
M 7	1	80	10	5,5	4,3	3	6	■		■	■
M 8	1,25	90	13	6	4,9	3	6,8	■		■	■
M 9	1,25	90	13	7	5,5	3	7,8	■			■
M 10	1,5	100	15	7	5,5	3	8,5	■		■	■
M 11	1,5	100	15	8	6,2	3	9,5	■			■
M 12	1,75	110	18	9	7	3	10,2	■	■	■	■
M 14	2	110	20	11	9	3	12	■	■	■	■
M 16	2	110	20	12	9	4	14	■	■	■	■
M 18	2,5	125	25	14	11	4	15,5	■	■	■	■
M 20	2,5	140	25	16	12	4	17,5	■	■	■	■
M 22	2,5	140	25	18	14,5	4	19,5	■	■	■	■
M 24	3	160	30	18	14,5	4	21	■	■	■	■
M 27	3	160	30	20	16	4	24	■	■	■	■
M 30	3,5	180	35	22	18	4	26,5	■	■	■	■
M 33	3,5	180	35	25	20	4	29,5	■	■	■	■
M 36	4	200	40	28	22	4	32	■	■	■	■

■ dodáváme standardně / standard supplies / Standardlieferbar

X.X Doporučené užití / Recommended use / Optimal

X.X Možno použít / Possible use / Geeignet

STROJNÍ ZÁVITNÍKY

Machine taps / Maschinengewindebohrer



Skupina obráběného materiálu
Material group / Werkstoffgruppe

10.1; 2.2		2400
2.2; 10.1; 6.2		2410
1.1; 1.2; 2.1; 2.2; 8.1; 9.1		2360
1.2; 1.1; 2.1; 2.2; 8.1		2390

Katalogové číslo / Cat. No. / Kat. Nr.								2400	2410	2360	2390
									TiN	TiN	OX
d ₁	P	l ₁	l ₂	d ₂	a	z	Ø mm				
M 3	0,5	56	5	3,5	2,7	3	2,5	■	■	■	■
M 3,5	0,6	56	6	4	3	3	2,9	■	■	■	■
M 4	0,7	63	7	4,5	3,4	3	3,3	■	■	■	■
M 4,5	0,75	70	8	6	4,9	3	3,7	■	■	■	■
M 5	0,8	70	8	6	4,9	3	4,2	■	■	■	■
M 6	1	80	10	6	4,9	3	5	■	■	■	■
M 7	1	80	10	7	5,5	3	6	■	■	■	■
M 8	1,25	90	13	8	6,2	3	6,8	■	■	■	■
M 9	1,25	90	13	9	7	3	7,8	■	■	■	■
M 10	1,5	100	15	10	8	3	8,5	■	■	■	■

■ dodáváme standardně / standard supplies / Standardlieferbar

X.X Doporučené užití / Recommended use / Optimal
X.X Možno použít / Possible use / Geeignet

STROJNÍ ZÁVITNÍKY

Machine taps / Maschinengewindebohrer



Skupina obráběného materiálu
Material group / Werkstoffgruppe

10.1; 2.2		4400
2.2; 10.1; 6.2		4410
1.1; 1.2; 2.1; 2.2; 8.1; 9.1		4360
1.2; 1.1; 2.1; 8.1		4390

Katalogové číslo / Cat. No. / Kat. Nr.								4400	4410	4360	4390		
<p>z = počet drážek / z = number of flutes / z = Nutenzahl</p>								TiN		TiN		OX	
<p>z = počet drážek / z = number of flutes / z = Nutenzahl</p>													
d ₁	P	l ₁	l ₂	d ₂	a	z	Ø mm						
M 3	0,5	56	5	2,2	-	3	2,5	■	■	■	■		
M 3,5	0,6	56	6	2,5	2,1	3	2,9	■	■	■	■		
M 4	0,7	63	7	2,8	2,1	3	3,3	■	■	■	■		
M 4,5	0,75	70	8	3,5	2,7	3	3,7	■	■	■	■		
M 5	0,8	70	8	3,5	2,7	3	4,2	■	■	■	■		
M 6	1	80	10	4,5	3,4	3	5	■	■	■	■		
M 7	1	80	10	5,5	4,3	3	6	■	■	■	■		
M 8	1,25	90	13	6	4,9	3	6,8	■	■	■	■		
M 9	1,25	90	13	7	5,5	3	7,8	■	■	■	■		
M 10	1,5	100	15	7	5,5	3	8,5	■	■	■	■		
M 11	1,5	100	15	8	6,2	3	9,5	■	■	■	■		
M 12	1,75	110	18	9	7	3	10,2	■	■	■	■		
M 14	2	110	20	11	9	3	12	■	■	■	■		
M 16	2	110	20	12	9	4	14	■	■	■	■		
M 18	2,5	125	25	14	11	4	15,5	■	■	■	■		
M 20	2,5	140	25	16	12	4	17,5	■	■	■	■		
M 22	2,5	140	25	18	14,5	4	19,5	■	■	■	■		
M 24	3	160	30	18	14,5	4	21	■	■	■	■		
M 27	3	160	30	20	16	4	24	■	■	■	■		
M 30	3,5	180	35	22	18	4	26,5	■	■	■	■		
M 33	3,5	180	35	25	20	4	29,5	■	■	■	■		
M 36	4	200	40	28	22	4	32	■	■	■	■		

■ dodáváme standardně / standard supplies / Standardlieferbar

X.X Doporučené užití / Recommended use / Optimal

X.X Možno použít / Possible use / Geeignet

STROJNÍ ZÁVITNÍKY

Machine taps / Maschinengewindebohrer



Skupina obráběného materiálu
Material group / Werkstoffgruppe

3.1; 5.1; 5.2; 9.1; 10.2  **1660**

3.1; 5.1; 5.2  **1690**

3.1; 5.1; 5.2; 9.1; 10.2; 3.3  **1870**

3.1; 5.1; 5.2; 9.1; 10.2; 3.3  **1870 IKZN**

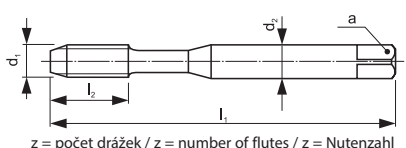
Katalogové číslo / Cat. No. / Kat. Nr.								1660	1690	1870	1870 IKZN
								TiN	OX	HL	HL
								HSSE	HSSE	HSSE PM	HSSE PM IKZN
d ₁	P	l ₁	l ₂	d ₂	a	z	Ø mm				
M 3	0,5	56	9	3,5	2,7	3	2,5	■	■	■	
M 3,5	0,6	56	11	4	3	3	2,9				
M 4	0,7	63	12	4,5	3,4	3	3,3	■	■	■	
M 4,5	0,75	70	13	6	4,9	3	3,7				
M 5	0,8	70	13	6	4,9	3	4,2	■	■	■	
M 6	1	80	15	6	4,9	3	5	■	■	■	■
M 7	1	80	15	7	5,5	3	6				
M 8	1,25	90	18	8	6,2	3	6,8	■	■	■	■
M 9	1,25	90	18	9	7	3	7,8				
M 10	1,5	100	20	10	8	3	8,5	■	■	■	■

■ dodáváme standardně / standard supplies / Standardlieferbar

X.X Doporučené užití / Recommended use / Optimal
X.X Možno použít / Possible use / Geeignet

STROJNÍ ZÁVITNÍKY

Machine taps / Maschinengewindebohrer



Skupina obráběného materiálu
Material group / Werkstoffgruppe

3.1; 5.1; 5.2; 9.1; 10.2  **3660**

3.1; 5.1; 5.2  **3690**

3.1; 5.1; 5.2; 9.1; 10.2; 3.3  **3870**

3.1; 5.1; 5.2; 9.1; 10.2; 3.3  **3870 IKZN**

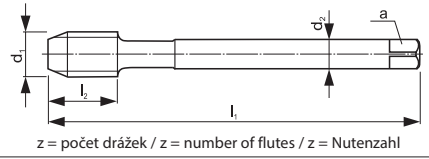
Katalogové číslo / Cat. No. / Kat. Nr.								3660	3690	3870	3870 IKZN
								TiN	OX	HL	HL
								HSSE	HSSE	HSSE PM	HSSE PM IKZN
d ₁	P	l ₁	l ₂	d ₂	a	z	Ø mm				
M 3	0,5	56	9	2,2	-	3	2,5	■	■		
M 3,5	0,6	56	11	2,5	2,1	3	2,9				
M 4	0,7	63	12	2,8	2,1	3	3,3	■	■		
M 4,5	0,75	70	13	3,5	2,7	3	3,7				
M 5	0,8	70	13	3,5	2,7	3	4,2	■	■		
M 6	1	80	15	4,5	3,4	3	5	■	■		
M 7	1	80	15	5,5	4,3	3	6				
M 8	1,25	90	18	6	4,9	3	6,8	■	■		
M 9	1,25	90	18	7	5,5	3	7,8				
M 10	1,5	100	20	7	5,5	3	8,5	■	■		
M 11	1,5	100	20	8	6,2	3	9,5				
M 12	1,75	110	23	9	7	3	10,2	■	■	■	■
M 14	2	110	25	11	9	3	12	■	■		
M 16	2	110	25	12	9	3	14	■	■		
M 18	2,5	125	30	14	11	3	15,5	■	■		
M 20	2,5	140	30	16	12	3	17,5	■	■		
M 22	2,5	140	30	18	14,5	3	19,5	■	■		
M 24	3	160	36	18	14,5	4	21	■	■		
M 27	3	160	36	20	16	4	24	■	■		
M 30	3,5	180	40	22	18	4	26,5	■	■		
M 33	3,5	180	42	25	20	4	29,5				
M 36	4	200	50	28	22	4	32				

■ dodáváme standardně / standard supplies / Standardlieferbar

X.X Doporučené užití / Recommended use / Optimal





X.X Možno použít / Possible use / Geeignet

STROJNÍ ZÁVITNÍKY

Machine taps / Maschinengewindebohrer



Skupina obráběného materiálu
Material group / Werkstoffgruppe

- 3.1; 3.3; 5.1; 5.2; 6.2; 9.1; 10.1  **2260**
- 3.1; 5.1; 5.2  **2290**
- 3.1; 3.3; 5.1; 5.2; 6.2; 9.1; 10.1  **2320**
- 3.1; 5.1; 5.2  **2320 IKZ**

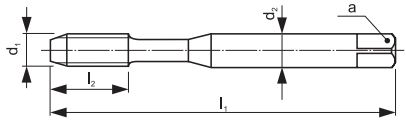



Katalogové číslo / Cat. No. / Kat. Nr.								2260	2290	2320	2320 IKZ
 <p>z = počet drážek / z = number of flutes / z = Nutenzahl</p>								TiN	OX	HL	HL
								HSSE	HSSE	HSSE PM	HSSE PM IKZ
d ₁	P	l ₁	l ₂	d ₂	a	z	Ø mm				
M 3	0,5	56	5	3,5	2,7	3	2,5	■	■	■	
M 3,5	0,6	56	6	4	3	3	2,9				
M 4	0,7	63	7	4,5	3,4	3	3,3	■	■	■	
M 4,5	0,75	70	8	6	4,9	3	3,7				
M 5	0,8	70	8	6	4,9	3	4,2	■	■	■	
M 6	1	80	10	6	4,9	3	5	■	■	■	■
M 7	1	80	10	7	5,5	3	6				
M 8	1,25	90	13	8	6,2	3	6,8	■	■	■	■
M 9	1,25	90	13	9	7	3	7,8				
M 10	1,5	100	15	10	8	3	8,5	■	■	■	■

■ dodáváme standardně / standard supplies / Standardlieferbar

X.X Doporučené užití / Recommended use / Optimal
X.X Možno použít / Possible use / Geeignet



Skupina obráběného materiálu
Material group / Werkstoffgruppe

- 3.1; 3.3; 5.1; 5.2; 6.2; 9.1; 10.1  **4260**
- 3.1; 5.1; 5.2  **4290**
- 3.1; 3.3; 5.1; 5.2; 6.2; 9.1; 10.1  **4320**
- 3.1; 3.3; 5.1; 5.2; 6.2; 9.1; 10.1  **4320 IKZ**

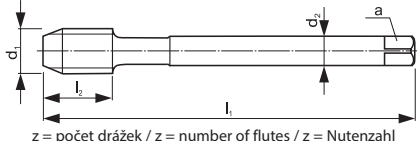
Katalogové číslo / Cat. No. / Kat. Nr.								4260	4290	4320	4320 IKZ
								TiN	OX	HL	HL
								HSSE	HSSE	HSSE PM	HSSE PM IKZ
d ₁	P	l ₁	l ₂	d ₂	a	z	Ø mm				
M 3	0,5	56	5	2,2	-	3	2,5	■	■		
M 3,5	0,6	56	6	2,5	2,1	3	2,9				
M 4	0,7	63	7	2,8	2,1	3	3,3	■	■		
M 4,5	0,75	70	8	3,5	2,7	3	3,7				
M 5	0,8	70	8	3,5	2,7	3	4,2	■	■		
M 6	1	80	10	4,5	3,4	3	5	■	■		
M 7	1	80	10	5,5	4,3	3	6				
M 8	1,25	90	13	6	4,9	3	6,8	■	■		
M 9	1,25	90	13	7	5,5	3	7,8				
M 10	1,5	100	15	7	5,5	3	8,5	■	■		
M 11	1,5	100	15	8	6,2	3	9,5				
M 12	1,75	110	18	9	7	3	10,2	■	■	■	■
M 14	2	110	20	11	9	3	12	■	■		
M 16	2	110	20	12	9	4	14	■	■		
M 18	2,5	125	25	14	11	4	15,5	■	■		
M 20	2,5	140	25	16	12	4	17,5	■	■		
M 22	2,5	140	25	18	14,5	4	19,5	■	■		
M 24	3	160	30	18	14,5	4	21	■	■		
M 27	3	160	30	20	16	4	24	■	■		
M 30	3,5	180	35	22	18	4	26,5	■	■		
M 33	3,5	180	35	25	20	4	29,5				
M 36	4	200	40	28	22	4	32				

■ dodáváme standardně / standard supplies / Standardlieferbar

X.X Doporučené užití / Recommended use / Optimal

X.X Možno použít / Possible use / Geeignet

STROJNÍ ZÁVITNÍKY

Machine taps / Maschinengewindebohrer



Skupina obráběného materiálu
Material group / Werkstoffgruppe

3.1; 3.2; 3.3; 6.2		1580
3.2; 8.2		1590
3.2; 3.1; 3.3; 6.2		2680
3.2		2690

Katalogové číslo / Cat. No. / Kat. Nr.								1580	1590	2680	2690	
<p>z = počet drážek / z = number of flutes / z = Nutenzahl</p>								TiCN	OX	TiCN	OX	
d ₁	P	l ₁	l ₂	l _{2R40°}	d ₂	a	z	Ø mm				
M 3	0,5	56	9	5	3,5	2,7	3	2,5	■	■	■	■
M 3,5	0,6	56	11	6	4	3	3	2,9	■	■	■	■
M 4	0,7	63	12	7	4,5	3,4	3	3,3	■	■	■	■
M 4,5	0,75	70	13	8	6	4,9	3	3,7	■	■	■	■
M 5	0,8	70	13	8	6	4,9	3	4,2	■	■	■	■
M 6	1	80	15	10	6	4,9	3	5	■	■	■	■
M 7	1	80	15	10	7	5,5	3	6	■	■	■	■
M 8	1,25	90	18	13	8	6,2	3	6,8	■	■	■	■
M 9	1,25	90	18	13	9	7	3	7,8	■	■	■	■
M 10	1,5	100	20	15	10	8	3	8,5	■	■	■	■

■ dodáváme standardně / standard supplies / Standardlieferbar

X.X Doporučené užití / Recommended use / Optimal
X.X Možno použít / Possible use / Geeignet

STROJNÍ ZÁVITNÍKY

Machine taps / Maschinengewindebohrer



Skupina obráběného materiálu
Material group / Werkstoffgruppe

3.1; 3.2; 3.3; 6.2



3580

3.2; 8.2



3590

3.2; 3.1; 3.3; 6.2



4680

3.2



4690

Katalogové číslo / Cat. No. / Kat. Nr.									3580	3590	4680	4690
<p>z = počet drážek / z = number of flutes / z = Nutenzahl</p>									TiCN	OX	TiCN	OX
d ₁	P	l ₁	l ₂	l _{2R40°}	d ₂	a	z / ZR40°	Ø mm				
M 3	0,5	56	9	5	2,2	-	3/3	2,5	■	■	■	■
M 3,5	0,6	56	11	6	2,5	2,1	3/3	2,9	■	■	■	■
M 4	0,7	63	12	7	2,8	2,1	3/3	3,3	■	■	■	■
M 4,5	0,75	70	13	8	3,5	2,7	3/3	3,7	■	■	■	■
M 5	0,8	70	13	8	3,5	2,7	3/3	4,2	■	■	■	■
M 6	1	80	15	10	4,5	3,4	3/3	5	■	■	■	■
M 7	1	80	15	10	5,5	4,3	3/3	6	■	■	■	■
M 8	1,25	90	18	13	6	4,9	3/3	6,8	■	■	■	■
M 9	1,25	90	18	13	7	5,5	3/3	7,8	■	■	■	■
M 10	1,5	100	20	15	7	5,5	3/3	8,5	■	■	■	■
M 11	1,5	100	20	15	8	6,2	3/3	9,5	■	■	■	■
M 12	1,75	110	23	18	9	7	3/4	10,2	■	■	■	■
M 14	2	110	25	20	11	9	3/4	12	■	■	■	■
M 16	2	110	25	20	12	9	3/4	14	■	■	■	■
M 18	2,5	125	30	25	14	11	3/4	15,5	■	■	■	■
M 20	2,5	140	30	25	16	12	3/4	17,5	■	■	■	■
M 22	2,5	140	30	25	18	14,5	3/4	19,5	■	■	■	■
M 24	3	160	36	30	18	14,5	4/4	21	■	■	■	■
M 27	3	160	36	30	20	16	4/4	24	■	■	■	■
M 30	3,5	180	40	35	22	18	4/5	26,5	■	■	■	■
M 33	3,5	180	42	35	25	20	4/5	29,5	■	■	■	■
M 36	4	200	50	40	28	22	4/5	32	■	■	■	■

■ dodáváme standardně / standard supplies / Standardlieferbar

X.X Doporučené užití / Recommended use / Optimal

X.X Možno použít / Possible use / Geeignet

STROJNÍ ZÁVITNÍKY

Machine taps / Maschinengewindebohrer



Skupina obráběného materiálu
Material group / Werkstoffgruppe

4.2; 4.1		1920
4.2; 4.1		3920
4.2; 4.1		2820
4.2; 4.1		4820
4.1; 4.2		2870
4.1; 4.2		4870

Katalogové číslo / Cat. No. / Kat. Nr.		1920	2820	2870																																																																																																		
 z = počet drážek / z = number of flutes / z = Nutenzahl		FNT	FNT	FNT																																																																																																		
<table border="1"> <thead> <tr> <th>d₁</th> <th>P</th> <th>l₁</th> <th>l₂</th> <th>l_{2R40°}</th> <th>d₂</th> <th>a</th> <th>z</th> <th>Ø mm</th> </tr> </thead> <tbody> <tr><td>M 3</td><td>0,5</td><td>56</td><td>9</td><td>5</td><td>3,5</td><td>2,7</td><td>3</td><td>2,5</td></tr> <tr><td>M 3,5</td><td>0,6</td><td>56</td><td>11</td><td>6</td><td>4</td><td>3</td><td>3</td><td>2,9</td></tr> <tr><td>M 4</td><td>0,7</td><td>63</td><td>12</td><td>7</td><td>4,5</td><td>3,4</td><td>3</td><td>3,3</td></tr> <tr><td>M 4,5</td><td>0,75</td><td>70</td><td>13</td><td>8</td><td>6</td><td>4,9</td><td>3</td><td>3,7</td></tr> <tr><td>M 5</td><td>0,8</td><td>70</td><td>13</td><td>8</td><td>6</td><td>4,9</td><td>3</td><td>4,2</td></tr> <tr><td>M 6</td><td>1</td><td>80</td><td>15</td><td>10</td><td>6</td><td>4,9</td><td>3</td><td>5</td></tr> <tr><td>M 7</td><td>1</td><td>80</td><td>15</td><td>10</td><td>7</td><td>5,5</td><td>3</td><td>6</td></tr> <tr><td>M 8</td><td>1,25</td><td>90</td><td>18</td><td>13</td><td>8</td><td>6,2</td><td>3</td><td>6,8</td></tr> <tr><td>M 9</td><td>1,25</td><td>90</td><td>18</td><td>13</td><td>9</td><td>7</td><td>3</td><td>7,8</td></tr> <tr><td>M 10</td><td>1,5</td><td>100</td><td>20</td><td>15</td><td>10</td><td>8</td><td>3</td><td>8,5</td></tr> </tbody> </table>		d ₁	P	l ₁	l ₂	l _{2R40°}	d ₂	a	z	Ø mm	M 3	0,5	56	9	5	3,5	2,7	3	2,5	M 3,5	0,6	56	11	6	4	3	3	2,9	M 4	0,7	63	12	7	4,5	3,4	3	3,3	M 4,5	0,75	70	13	8	6	4,9	3	3,7	M 5	0,8	70	13	8	6	4,9	3	4,2	M 6	1	80	15	10	6	4,9	3	5	M 7	1	80	15	10	7	5,5	3	6	M 8	1,25	90	18	13	8	6,2	3	6,8	M 9	1,25	90	18	13	9	7	3	7,8	M 10	1,5	100	20	15	10	8	3	8,5	 B 3,5 - 6 D 3,5 - 5 C 2 - 3	 D 15° C 40°
d ₁	P	l ₁	l ₂	l _{2R40°}	d ₂	a	z	Ø mm																																																																																														
M 3	0,5	56	9	5	3,5	2,7	3	2,5																																																																																														
M 3,5	0,6	56	11	6	4	3	3	2,9																																																																																														
M 4	0,7	63	12	7	4,5	3,4	3	3,3																																																																																														
M 4,5	0,75	70	13	8	6	4,9	3	3,7																																																																																														
M 5	0,8	70	13	8	6	4,9	3	4,2																																																																																														
M 6	1	80	15	10	6	4,9	3	5																																																																																														
M 7	1	80	15	10	7	5,5	3	6																																																																																														
M 8	1,25	90	18	13	8	6,2	3	6,8																																																																																														
M 9	1,25	90	18	13	9	7	3	7,8																																																																																														
M 10	1,5	100	20	15	10	8	3	8,5																																																																																														

Katalogové číslo / Cat. No. / Kat. Nr.		3920	4820	4870																	
 z = počet drážek / z = number of flutes / z = Nutenzahl		FNT	FNT	FNT																	
<table border="1"> <thead> <tr> <th>d₁</th> <th>P</th> <th>l₁</th> <th>l₂</th> <th>l_{2R40°}</th> <th>d₂</th> <th>a</th> <th>z</th> <th>Ø mm</th> </tr> </thead> <tbody> <tr><td>M 12</td><td>1,75</td><td>110</td><td>23</td><td>18</td><td>9</td><td>7</td><td>3</td><td>10,2</td></tr> </tbody> </table>		d ₁	P	l ₁	l ₂	l _{2R40°}	d ₂	a	z	Ø mm	M 12	1,75	110	23	18	9	7	3	10,2	 B 3,5 - 6 D 3,5 - 5 C 2 - 3	 D 15° C 40°
d ₁	P	l ₁	l ₂	l _{2R40°}	d ₂	a	z	Ø mm													
M 12	1,75	110	23	18	9	7	3	10,2													

■ dodáváme standardně / standard supplies / Standardlieferbar

X.X Doporučené užití / Recommended use / Optimal
X.X Možno použít / Possible use / Geeignet

STROJNÍ ZÁVITNÍKY

Machine taps / Maschinengewindebohrer



Skupina obráběného materiálu
Material group / Werkstoffgruppe



8.2	1570	7.1	1620
8.2	3570	7.1	3620
8.2	2670	7.1	2720
8.2	4670	7.1	4720

Katalogové číslo / Cat. No. / Kat. Nr.		1570	1620	2670	2720								
<p>DIN 371</p> <p>z = počet drážek / z = number of flutes / z = Nutenzahl</p>													
<p>B 3,5 - 6</p> <p>C 2 - 3</p>													
d ₁	P	l ₁	l ₂	l _{2R45}	d ₂	a	z / Z _{R45}		Ø mm				
M 3	0,5	56	9	5	3,5	2,7	3/2		2,5	■	■	■	■
M 3,5	0,6	56	11	6	4	3	3/2		2,9	■	■	■	■
M 4	0,7	63	12	7	4,5	3,4	3/2		3,3	■	■	■	■
M 4,5	0,75	70	13	8	6	4,9	3/2		3,7	■	■	■	■
M 5	0,8	70	13	8	6	4,9	3/2		4,2	■	■	■	■
M 6	1	80	15	10	6	4,9	3/2		5	■	■	■	■
M 7	1	80	15	10	7	5,5	3/2		6	■	■	■	■
M 8	1,25	90	18	13	8	6,2	3/2		6,8	■	■	■	■
M 9	1,25	90	18	13	9	7	3/2		7,8	■	■	■	■
M 10	1,5	100	20	15	10	8	3/2		8,5	■	■	■	■

Katalogové číslo / Cat. No. / Kat. Nr.		3570	3620	4670	4720								
<p>DIN 376</p> <p>z = počet drážek / z = number of flutes / z = Nutenzahl</p>													
<p>B 3,5 - 6</p> <p>C 2 - 3</p>													
d ₁	P	l ₁	l ₂	l _{2R45}	d ₂	a	z / Z _{R45}		Ø mm				
M 3	0,5	56	9	5	2,2	-	3/2		2,5	■	■	■	■
M 3,5	0,6	56	11	6	2,5	2,1	3/2		2,9	■	■	■	■
M 4	0,7	63	12	7	2,8	2,1	3/2		3,3	■	■	■	■
M 4,5	0,75	70	13	8	3,5	2,7	3/2		3,7	■	■	■	■
M 5	0,8	70	13	8	3,5	2,7	3/2		4,2	■	■	■	■
M 6	1	80	15	10	4,5	3,4	3/2		5	■	■	■	■
M 7	1	80	15	10	5,5	4,3	3/2		6	■	■	■	■
M 8	1,25	90	18	13	6	4,9	3/2		6,8	■	■	■	■
M 9	1,25	90	18	13	7	5,5	3/2		7,8	■	■	■	■
M 10	1,5	100	20	15	7	5,5	3/2		8,5	■	■	■	■
M 11	1,5	100	20	15	8	6,2	3/2		9,5	■	■	■	■
M 12	1,75	110	23	18	9	7	3/2		10,2	■	■	■	■
M 14	2	110	25	20	11	9	3/2		12	■	■	■	■
M 16	2	110	25	20	12	9	3/2		14	■	■	■	■
M 18	2,5	125	30	25	14	11	3/3		15,5	■	■	■	■
M 20	2,5	140	30	25	16	12	3/3		17,5	■	■	■	■
M 22	2,5	140	30	25	18	14,5	3/3		19,5	■	■	■	■
M 24	3	160	36	30	18	14,5	4/3		21	■	■	■	■
M 27	3	160	36	30	20	16	4/3		24	■	■	■	■
M 30	3,5	180	40	35	22	18	4/3		26,5	■	■	■	■
M 33	3,5	180	42	35	25	20	4/3		29,5	■	■	■	■
M 36	4	200	50	40	28	22	4/3		32	■	■	■	■

■ dodáváme standardně / standard supplies / Standardlieferbar

X.X Doporučené užití / Recommended use / Optimal

X.X Možno použít / Possible use / Geeignet

STROJNÍ ZÁVITNÍKY

Machine taps / Maschinengewindebohrer



Skupina obráběného materiálu
Material group / Werkstoffgruppe



Katalogové číslo / Cat. No. / Kat. Nr.								1080	1080 IKZ	1130	1130 IKZ
								TiCN	TiCN	TiCN	TiCN
								C 2-3	C 2-3 IKZ	E 1,5	E 1,5 IKZ
d ₁	P	l ₁	l ₂	d ₂	a	z	Ø mm				
M 3	0,5	56	9	3,5	2,7	3	2,5	■		■	
M 3,5	0,6	56	11	4	3	3	2,9				
M 4	0,7	63	12	4,5	3,4	3	3,3	■		■	
M 4,5	0,75	70	13	6	4,9	3	3,7				
M 5	0,8	70	13	6	4,9	3	4,2	■	■	■	■
M 6	1	80	15	6	4,9	3	5	■	■	■	■
M 7	1	80	15	7	5,5	3	6				
M 8	1,25	90	18	8	6,2	4	6,8	■	■	■	■
M 9	1,25	90	18	9	7	4	7,8				
M 10	1,5	100	20	10	8	4	8,5	■	■	■	■

■ dodáváme standardně / standard supplies / Standardlieferbar

X.X Doporučené užití / Recommended use / Optimal
X.X Možno použít / Possible use / Geeignet

STROJNÍ ZÁVITNÍKY

Machine taps / Maschinengewindebohrer



Skupina obráběného materiálu
Material group / Werkstoffgruppe



Katalogové číslo / Cat. No. / Kat. Nr.								3080	3080 IKZ	3130	3130 IKZ
								TiCN	TiCN	TiCN	TiCN
								C 2-3	C 2-3 IKZ	E 1,5	E 1,5 IKZ
d ₁	P	l ₁	l ₂	d ₂	a	z	Ø mm				
M 3	0,5	56	9	2,2	-	3	2,5	■		■	
M 3,5	0,6	56	11	2,5	2,1	3	2,9				
M 4	0,7	63	12	2,8	2,1	3	3,3	■		■	
M 4,5	0,75	70	13	3,5	2,7	3	3,7				
M 5	0,8	70	13	3,5	2,7	3	4,2	■	■	■	■
M 6	1	80	15	4,5	3,4	3	5	■	■	■	■
M 7	1	80	15	5,5	4,3	3	6				
M 8	1,25	90	18	6	4,9	4	6,8	■	■	■	■
M 9	1,25	90	18	7	5,5	4	7,8				
M 10	1,5	100	20	7	5,5	4	8,5	■	■	■	■
M 11	1,5	100	20	8	6,2	4	9,5				
M 12	1,75	110	23	9	7	4	10,2	■	■	■	■
M 14	2	110	25	11	9	4	12	■	■	■	■
M 16	2	110	25	12	9	4	14	■		■	
M 18	2,5	125	30	14	11	4	15,5	■		■	
M 20	2,5	140	30	16	12	4	17,5	■		■	
M 22	2,5	140	30	18	14,5	4	19,5	■		■	
M 24	3	160	36	18	14,5	4	21	■		■	
M 27	3	160	36	20	16	4	24	■		■	
M 30	3,5	180	40	22	18	4	26,5	■		■	
M 33	3,5	180	42	25	20	5	29,5				
M 36	4	200	50	28	22	5	32				

■ dodáváme standardně / standard supplies / Standardlieferbar

X.X Doporučené užití / Recommended use / Optimal

X.X Možno použít / Possible use / Geeignet

STROJNÍ ZÁVITNÍKY

Machine taps / Maschinengewindebohrer



Skupina obráběného materiálu
Material group / Werkstoffgruppe

2.2; 3.1; 3.2; 8.1; 10.2; 2.1; 3.3; 5.1; 5.2; 6.1; 6.2; 8.2		1710
2.2; 3.1; 3.2; 8.1; 10.2; 2.1; 3.3; 5.1; 5.2; 6.1; 6.2; 8.2		3710
2.2; 3.1; 3.2; 8.1; 10.2; 2.1; 3.3; 5.1; 5.2; 6.1; 6.2; 8.2		2210
2.2; 3.1; 3.2; 8.1; 10.2; 2.1; 3.3; 5.1; 5.2; 6.1; 6.2; 8.2		4210

Katalogové číslo / Cat. No. / Kat. Nr.										1710	2210
<p>DIN 371</p> <p>z = počet drážek / z = number of flutes / z = Nutenzahl</p>										TiN	TiN
d ₁	P	l ₁	l ₂	l ₂ R35°	d ₂	a	z / ZR35°		Ø mm		
M 3	0,5	56	9	5	3,5	2,7	3		2,5	■	■
M 3,5	0,6	56	11	6	4	3	3		2,9	■	■
M 4	0,7	63	12	7	4,5	3,4	3		3,3	■	■
M 4,5	0,75	70	13	8	6	4,9	3		3,7	■	■
M 5	0,8	70	13	8	6	4,9	3		4,2	■	■
M 6	1	80	15	10	6	4,9	3		5	■	■
M 7	1	80	15	10	7	5,5	3		6	■	■
M 8	1,25	90	18	13	8	6,2	3		6,8	■	■
M 9	1,25	90	18	13	9	7	3		7,8	■	■
M 10	1,5	100	20	15	10	8	3		8,5	■	■

Katalogové číslo / Cat. No. / Kat. Nr.										3710	4210
<p>DIN 376</p> <p>z = počet drážek / z = number of flutes / z = Nutenzahl</p>										TiN	TiN
d ₁	P	l ₁	l ₂	l ₂ R35°	d ₂	a	z / ZR35°		Ø mm		
M 3	0,5	56	9	5	2,2	-	3/3		2,5		
M 3,5	0,6	56	11	6	2,5	2,1	3/3		2,9		
M 4	0,7	63	12	7	2,8	2,1	3/3		3,3		
M 4,5	0,75	70	13	8	3,5	2,7	3/3		3,7		
M 5	0,8	70	13	8	3,5	2,7	3/3		4,2		
M 6	1	80	15	10	4,5	3,4	3/3		5		
M 7	1	80	15	10	5,5	4,3	3/3		6		
M 8	1,25	90	18	13	6	4,9	3/3		6,8		
M 9	1,25	90	18	13	7	5,5	3/3		7,8		
M 10	1,5	100	20	15	7	5,5	3/3		8,5		
M 11	1,5	100	20	15	8	6,2	3/3		9,5		
M 12	1,75	110	23	18	9	7	3/3		10,2	■	■
M 14	2	110	25	20	11	9	3/3		12	■	■
M 16	2	110	25	20	12	9	3/4		14	■	■
M 18	2,5	125	30	25	14	11	3/4		15,5	■	■
M 20	2,5	140	30	25	16	12	3/4		17,5	■	■

■ dodáváme standardně / standard supplies / Standardlieferbar

X.X Doporučené užití / Recommended use / Optimal
X.X Možno použít / Possible use / Geeignet

STROJNÍ ZÁVITNÍKY

Machine taps / Maschinengewindebohrer

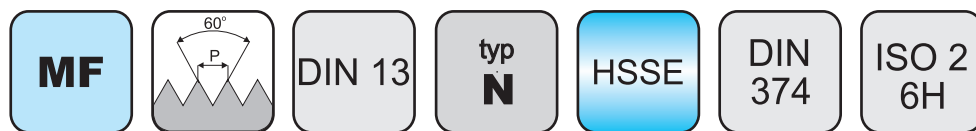

Skupina obráběného materiálu
Material group / Werkstoffgruppe

10.1; 1.1; 2.1; 6.1; 8.2		3000
8.2; 10.1; 1.1; 2.1; 6.1		3010
1.2; 2.2; 8.1; 1.1; 2.1; 2.3; 6.2; 8.2; 10.1		3500
1.1; 1.2; 2.1; 2.2; 2.3; 6.2; 8.1; 8.2; 10.1		3510
1.2; 2.2; 8.1; 11.1; 2.3; 8.2		3540

Katalogové číslo / Cat. No. / Kat. Nr.								3000	3010	3500	3510	3540
<p>z = počet drážek / z = number of flutes / z = Nutenzahl</p>								TiN		TiN	OX	
d ₁	P	l ₁	l ₂	d ₂	a	z	Ø mm					
M 3	0,35	56	8	2,2	-	3	2,65					
M 3,5	0,35	56	8	2,5	2,1	3	3,15					
M 4	0,5	63	12	2,8	2,1	3	3,5	■	■	■	■	■
M 4	0,35	63	12	2,8	2,1	3	3,65					
M 4,5	0,5	70	13	3,5	2,7	3	4					
M 5	0,5	70	13	3,5	2,7	3	4,5	■	■	■	■	■
M 5,5	0,5	80	15	4	3	3	5					
M 6	0,75	80	15	4,5	3,4	3	5,2	■	■	■	■	■
M 6	0,5	80	15	4,5	3,4	3	5,5	■	■	■	■	■
M 7	0,75	80	15	5,5	4,3	3	6,2	■	■	■	■	■
M 8	1	90	18	6	4,9	3	7	■	■	■	■	■
M 8	0,75	80	15	6	4,9	3	7,2	■	■	■	■	■
M 8	0,5	80	15	6	4,9	3	7,5					
M 9	1	90	18	7	5,5	3	8	■	■			
M 9	0,75	80	18	7	5,5	3	8,2					
M 10	1,25	100	20	7	5,5	3	8,8	■	■	■	■	■
M 10	1	90	20	7	5,5	3	9	■	■	■	■	■
M 10	0,75	90	20	7	5,5	3	9,2	■	■	■	■	■
M 11	1	90	20	8	6,2	3	10	■	■			
M 11	0,75	90	20	8	6,2	3	10,2					
M 12	1,5	100	21	9	7	3	10,5	■	■	■	■	■
M 12	1,25	100	21	9	7	3	10,8	■	■	■	■	■
M 12	1	100	21	9	7	3	11	■	■	■	■	■
M 13	1	100	21	11	9	3	12					
M 14	1,5	100	21	11	9	3	12,5	■	■	■	■	■
M 14	1,25	100	21	11	9	3	12,8	■	■	■	■	■
M 14	1	100	21	11	9	3	13	■	■	■	■	■
M 15	1,5	100	21	12	9	3	13,5	■	■	■	■	■
M 15	1	100	21	12	9	3	14	■	■	■	■	■
M 16	1,5	100	21	12	9	3	14,5	■	■	■	■	■
M 16	1	100	21	12	9	3	15	■	■	■	■	■
M 17	1,5	100	21	12	9	3	15,5					
M 17	1	100	21	12	9	3	16	■	■			
M 18	2	125	24	14	11	3	16	■	■	■	■	■
M 18	1,5	110	24	14	11	3	16,5	■	■	■	■	■
M 18	1	110	24	14	11	3	17	■	■	■	■	■
M 20	2	140	30	16	12	3	18	■	■	■	■	■
M 20	1,5	125	24	16	12	3	18,5	■	■	■	■	■
M 20	1	125	24	16	12	3	19	■	■	■	■	■
M 22	2	140	30	18	14,5	3	20	■	■	■	■	■
M 22	1,5	125	24	18	14,5	3	20,5	■	■	■	■	■
M 22	1	125	24	18	14,5	3	21	■	■	■	■	■
M 24	2	140	26	18	14,5	4	22	■	■	■	■	■
M 24	1,5	140	26	18	14,5	4	22,5	■	■	■	■	■
M 24	1	140	26	18	14,5	4	23	■	■	■	■	■
M 25	2	140	26	18	14,5	4	23					

■ dodáváme standardně / standard supplies / Standardlieferbar

X.X Doporučené užití / Recommended use / Optimal

X.X Možné použít / Possible use / Geeignet

STROJNÍ ZÁVITNÍKY

Machine taps / Maschinengewindebohrer

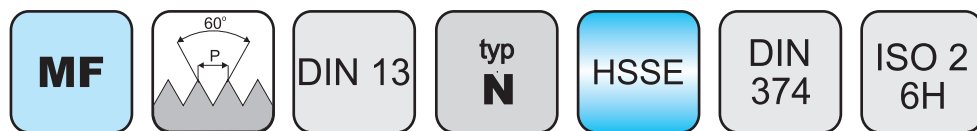

Skupina obráběného materiálu
Material group / Werkstoffgruppe

10.1; 1.1; 2.1; 6.1; 8.2

8.2; 10.1; 1.1; 2.1; 6.1

1.2; 2.2; 8.1; 1.1; 2.1; 2.3; 6.2; 8.2; 10.1

1.1; 1.2; 2.1; 2.2; 2.3; 6.2; 8.1; 8.2; 10.1

1.2; 2.2; 8.1; 11.1; 2.3; 8.2



Katalogové číslo / Cat. No. / Kat. Nr.								3000	3010	3500	3510	3540
								TiN		TiN	OX	
d ₁	P	l ₁	l ₂	d ₂	a	z	Ø mm					
M 25	1,5	140	26	18	14,5	4	23,5	■	■	■	■	■
M 26	1,5	140	26	18	14,5	4	24,5	■	■	■	■	■
M 27	2	140	26	20	16	4	25	■	■	■	■	■
M 27	1,5	140	26	20	16	4	25,5	■	■	■	■	■
M 27	1	140	26	20	16	4	26	■	■	■	■	■
M 28	2	140	26	20	16	4	26	■	■	■	■	■
M 28	1,5	140	26	20	16	4	26,5	■	■	■	■	■
M 30	2	150	28	22	18	4	28	■	■	■	■	■
M 30	1,5	150	28	22	18	4	28,5	■	■	■	■	■
M 30	1	150	28	22	18	4	29	■	■	■	■	■
M 32	1,5	150	28	22	18	4	30,5	■	■	■	■	■
M 33	2	160	30	25	20	4	31	■	■	■	■	■
M 33	1,5	160	30	25	20	4	31,5	■	■	■	■	■
M 34	1,5	170	30	28	22	4	32,5	■	■	■	■	■
M 35	1,5	170	30	28	22	4	33,5	■	■	■	■	■
M 36	3	200	42	28	22	4	33	■	■	■	■	■
M 36	2	170	30	28	22	4	34	■	■	■	■	■
M 36	1,5	170	30	28	22	4	34,5	■	■	■	■	■
M 38	1,5	170	30	28	22	4	36,5	■	■	■	■	■
M 39	3	200	42	32	24	4	36	■	■	■	■	■
M 39	2	170	30	32	24	4	37	■	■	■	■	■
M 39	1,5	170	30	32	24	4	37,5	■	■	■	■	■
M 40	3	200	42	32	24	4	37	■	■	■	■	■
M 40	2	170	30	32	24	4	38	■	■	■	■	■
M 40	1,5	170	30	32	24	4	38,5	■	■	■	■	■
M 42	3	200	50	32	24	4	39	■	■	■	■	■
M 42	2	170	30	32	24	4	40	■	■	■	■	■
M 42	1,5	170	30	32	24	4	40,5	■	■	■	■	■
M 45	3	200	50	36	29	4	42	■	■	■	■	■
M 45	2	180	32	36	29	4	43	■	■	■	■	■
M 45	1,5	180	32	36	29	4	43,5	■	■	■	■	■
M 48	3	225	50	36	29	4	45	■	■	■	■	■
M 48	2	190	32	36	29	4	46	■	■	■	■	■
M 48	1,5	190	32	36	29	4	46,5	■	■	■	■	■
M 50	3	225	50	36	29	4	47	■	■	■	■	■
M 50	2	190	32	36	29	4	48	■	■	■	■	■
M 50	1,5	190	32	36	29	4	48,5	■	■	■	■	■
M 52	3	225	50	40	32	4	49	■	■	■	■	■
M 52	2	190	32	40	32	4	50	■	■	■	■	■
M 52	1,5	190	32	40	32	4	50,5	■	■	■	■	■

■ dodáváme standardně / standard supplies / Standardlieferbar

X.X Doporučené užití / Recommended use / Optimal
X.X Možno použít / Possible use / Geeignet

STROJNÍ ZÁVITNÍKY

Machine taps / Maschinengewindebohrer



Skupina obráběného materiálu
Material group / Werkstoffgruppe

2.2; 2.3; 8.1; 6.2; 10.2



4050

2.2; 2.3; 8.1; 6.2; 8.2; 10.2



4060

11.1; 2.2; 2.3; 8.1; 8.2



4090

Katalogové číslo / Cat. No. / Kat. Nr.								4050	4060	4090
									TiN	OX
d ₁	P	l ₁	l ₂	d ₂	a	z	Ø mm			
M 3	0,35	56	5	2,2	-	3	2,65			
M 3,5	0,35	56	6	2,5	2,1	3	3,15			
M 4	0,5	63	7	2,8	2,1	3	3,5	■	■	■
M 4	0,35	63	7	2,8	2,1	3	3,65			
M 4,5	0,5	70	8	3,5	2,7	3	4			
M 5	0,5	70	8	3,5	2,7	3	4,5	■	■	■
M 5,5	0,5	80	7	4	3	3	5			
M 6	0,75	80	10	4,5	3,4	3	5,2	■	■	■
M 6	0,5	80	10	4,5	3,4	3	5,5	■	■	■
M 7	0,75	80	10	5,5	4,3	3	6,2	■	■	■
M 8	1	90	13	6	4,9	3	7	■	■	■
M 8	0,75	80	10	6	4,9	3	7,2	■	■	■
M 8	0,5	80	10	6	4,9	3	7,5			
M 9	1	90	13	7	5,5	3	8	■	■	■
M 9	0,75	80	10	7	5,5	3	8,2			
M 10	1,25	100	15	7	5,5	3	8,8	■	■	■
M 10	1	90	12	7	5,5	3	9	■	■	■
M 10	0,75	90	12	7	5,5	3	9,2			
M 11	1	90	12	8	6,2	3	10	■	■	■
M 11	0,75	90	12	8	6,2	3	10,2			
M 12	1,5	100	14	9	7	3	10,5	■	■	■
M 12	1,25	100	14	9	7	3	10,8	■	■	■
M 12	1	100	14	9	7	3	11	■	■	■
M 13	1	100	15	11	9	3	12			
M 14	1,5	100	16	11	9	3	12,5	■	■	■
M 14	1,25	100	16	11	9	3	12,8	■	■	■
M 14	1	100	16	11	9	3	13	■	■	■
M 15	1,5	100	17	12	9	3	13,5			
M 15	1	100	16	12	9	3	14	■	■	■
M 16	1,5	100	16	12	9	4	14,5	■	■	■
M 16	1	100	16	12	9	4	15	■	■	■
M 17	1,5	100	17	12	9	4	15,5			
M 17	1	100	16	12	9	4	16			
M 18	2	125	20	14	11	4	16	■	■	■
M 18	1,5	110	20	14	11	4	16,5	■	■	■
M 18	1	110	20	14	11	4	17	■	■	■
M 20	2	140	20	16	12	4	18	■	■	■
M 20	1,5	125	20	16	12	4	18,5	■	■	■
M 20	1	125	20	16	12	4	19	■	■	■
M 22	2	140	20	18	14,5	4	20	■	■	■
M 22	1,5	125	20	18	14,5	4	20,5	■	■	■
M 22	1	125	20	18	14,5	4	21	■	■	■
M 24	2	140	22	18	14,5	4	22	■	■	■
M 24	1,5	140	22	18	14,5	4	22,5	■	■	■
M 24	1	140	22	18	14,5	4	23	■	■	■
M 25	2	140	22	18	14,5	4	23			
M 25	1,5	140	22	18	14,5	4	23,5	■	■	■
M 26	1,5	140	22	18	14,5	4	24,5	■	■	■
M 27	2	140	22	20	16	4	25	■	■	■
M 27	1,5	140	22	20	16	4	25,5	■	■	■

■ dodáváme standardně / standard supplies / Standardlieferbar

X.X Doporučené užití / Recommended use / Optimal

X.X Možno použít / Possible use / Geeignet



Skupina obráběného materiálu
Material group / Werkstoffgruppe

2.2; 2.3; 8.1; 6.2; 10.2



4050

2.2; 2.3; 8.1; 6.2; 8.2; 10.2



4060

11.1; 2.2; 2.3; 8.1; 8.2



4090

Katalogové číslo / Cat. No. / Kat. Nr.								4050	4060	4090
<p>z = počet drážek / z = number of flutes / z = Nutenzahl</p>									TiN	OX
d ₁	P	l ₁	l ₂	d ₂	a	z				
M 27	1	140	22	20	16	4	26	■	■	■
M 28	2	140	22	20	16	4	26	■	■	■
M 28	1,5	140	22	20	16	4	26,5	■	■	■
M 30	2	150	26	22	18	4	28	■	■	■
M 30	1,5	150	26	22	18	4	28,5	■	■	■
M 30	1	150	26	22	18	4	29	■	■	■
M 32	1,5	150	26	22	18	4	30,5	■	■	■
M 33	2	160	28	25	20	4	31	■	■	■
M 33	1,5	160	28	25	20	4	31,5	■	■	■
M 34	1,5	170	28	28	22	4	32,5	■	■	■
M 35	1,5	170	30	28	22	4	33,5	■	■	■
M 36	3	200	36	28	22	4	33	■	■	■
M 36	2	170	28	28	22	4	34	■	■	■
M 36	1,5	170	28	28	22	4	34,5	■	■	■

■ dodáváme standardně / standard supplies / Standardlieferbar

X.X Doporučené užití / Recommended use / Optimal
X.X Možno použít / Possible use / Geeignet

STROJNÍ ZÁVITNÍKY

Machine taps / Maschinengewindebohrer



Skupina obráběného materiálu
Material group / Werkstoffgruppe

3.1; 5.1; 5.2; 9.1; 10.2

3.1; 5.1; 5.2

3.1; 3.3; 5.1; 5.2; 6.2; 9.1; 10.1

3.1; 5.1; 5.2



3660



3690



4260



4290

Katalogové číslo / Cat. No. / Kat. Nr.									3660	3690	4260	4290
<p>z = počet drážek / z = number of flutes / z = Nutenzahl</p>									TiN	OX	TiN	OX
d ₁	P	l ₁	l ₂	l _{2R35}	d ₂	a	z / Z _{R35}	Ø mm				
M 3	0,35	56	8	5	2,2	-	3/3	2,65				
M 3,5	0,35	56	8	6	2,5	2,1	3/3	3,15				
M 4	0,5	63	12	7	2,8	2,1	3/3	3,5				
M 4	0,35	63	12	7	2,8	2,1	3/3	3,65				
M 4,5	0,5	70	13	8	3,5	2,7	3/3	4				
M 5	0,5	70	13	8	3,5	2,7	3/3	4,5				
M 5,5	0,5	80	15	7	4	3	3/3	5				
M 6	0,75	80	15	10	4,5	3,4	3/3	5,2	■	■	■	■
M 6	0,5	80	15	10	4,5	3,4	3/3	5,5				
M 7	0,75	80	15	10	5,5	4,3	3/3	6,2				
M 8	1	90	18	13	6	4,9	3/3	7	■	■	■	■
M 8	0,75	80	15	10	6	4,9	3/3	7,2	■	■	■	■
M 8	0,5	80	15	10	6	4,9	3/3	7,5				
M 9	1	90	18	13	7	5,5	3/3	8				
M 9	0,75	80	18	10	7	5,5	3/3	8,2				
M 10	1,25	100	20	15	7	5,5	3/3	8,8				
M 10	1	90	20	12	7	5,5	3/3	9	■	■	■	■
M 10	0,75	90	20	12	7	5,5	3/3	9,2				
M 11	1	90	20	12	8	6,2	3/3	10				
M 11	0,75	90	20	12	8	6,2	3/3	10,2				
M 12	1,5	100	21	14	9	7	3/3	10,5	■	■	■	■
M 12	1,25	100	21	14	9	7	3/3	10,8				
M 12	1	100	21	14	9	7	3/3	11	■	■	■	■
M 13	1	100	21	15	11	9	3/3	12				
M 14	1,5	100	21	16	11	9	3/3	12,5	■	■	■	■
M 14	1,25	100	21	16	11	9	3/3	12,8				
M 14	1	100	21	16	11	9	3/3	13				
M 15	1,5	100	21	17	12	9	3/3	13,5				
M 15	1	100	21	16	12	9	3/3	14				
M 16	1,5	100	21	16	12	9	3/4	14,5	■	■	■	■
M 16	1	100	21	16	12	9	3/4	15				
M 17	1,5	100	21	17	12	9	3/4	15,5				
M 17	1	100	21	16	12	9	3/4	16				
M 18	2	125	24	20	14	11	3/4	16				
M 18	1,5	110	24	20	14	11	3/4	16,5	■	■	■	■
M 18	1	110	24	20	14	11	3/4	17				
M 20	2	140	30	20	16	12	3/4	18				
M 20	1,5	125	24	20	16	12	3/4	18,5	■	■	■	■
M 20	1	125	24	20	16	12	3/4	19				
M 22	2	140	30	20	18	14,5	3/4	20				
M 22	1,5	125	24	20	18	14,5	3/4	20,5				
M 22	1	125	24	20	18	14,5	3/4	21				
M 24	2	140	26	22	18	14,5	4/4	22				
M 24	1,5	140	26	22	18	14,5	4/4	22,5				
M 24	1	140	26	22	18	14,5	4/4	23				
M 25	2	140	26	22	18	14,5	4/4	23				

■ dodáváme standardně / standard supplies / Standardlieferbar

X.X Doporučené užití / Recommended use / Optimal

X.X Možné použít / Possible use / Geeignet



Skupina obráběného materiálu
Material group / Werkstoffgruppe

3.1; 5.1; 5.2; 9.1; 10.2



3660

3.1; 5.1; 5.2



3690

3.1; 3.3; 5.1; 5.2; 6.2; 9.1; 10.1



4260

3.1; 5.1; 5.2



4290

Katalogové číslo / Cat. No. / Kat. Nr.									3660	3690	4260	4290
<p>z = počet drážek / z = number of flutes / z = Nutenzahl</p>									TiN	OX	TiN	OX
d ₁	P	l ₁	l ₂	l _{3R35}	d ₂	a	z / Z _{R35}	Ø mm				
M 25	1,5	140	26	22	18	14,5	4/4	23,5				
M 26	1,5	140	26	22	18	14,5	4/4	24,5				
M 27	2	140	26	22	20	16	4/4	25				
M 27	1,5	140	26	22	20	16	4/4	25,5				
M 27	1	140	26	22	20	16	4/4	26				
M 28	2	140	26	22	20	16	4/4	26				
M 28	1,5	140	26	22	20	16	4/4	26,5				
M 30	2	150	28	26	22	18	4/4	28				
M 30	1,5	150	28	26	22	18	4/4	28,5				
M 30	1	150	28	26	22	18	4/4	29				
M 32	1,5	150	28	26	22	18	4/4	30,5				
M 33	2	160	30	28	25	20	4/4	31				
M 33	1,5	160	30	28	25	20	4/4	31,5				
M 34	1,5	170	30	28	28	22	4/4	32,5				
M 35	1,5	170	30	30	28	22	4/4	33,5				
M 36	3	200	42	36	28	22	4/4	33				
M 36	2	170	30	28	28	22	4/4	34				
M 36	1,5	170	30	28	28	22	4/4	34,5				

■ dodáváme standardně / standard supplies / Standardlieferbar

X.X Doporučené užití / Recommended use / Optimal
X.X Možno použít / Possible use / Geeignet

STROJNÍ ZÁVITNÍKY

Machine taps / Maschinengewindebohrer



Skupina obráběného materiálu
Material group / Werkstoffgruppe

3.1; 3.2; 3.3; 8.2; 6.2



3580

3.2; 8.2



3590

3.2; 8.2; 3.1; 3.3; 6.2



4680

3.2



4690

Katalogové číslo / Cat. No. / Kat. Nr.									3580	3590	4680	4690
<p>z = počet drážek / z = number of flutes / z = Nutenzahl</p>									TiCN	OX	TiCN	OX
d ₁	P	l ₁	l ₂	l _{2R40°}	d ₂	a	z / ZR40°	Ø mm				
M 3	0,35	56	8	5	2,2	-	3/3	2,65				
M 3,5	0,35	56	8	6	2,5	2,1	3/3	3,15				
M 4	0,5	63	12	7	2,8	2,1	3/3	3,5				
M 4	0,35	63	12	7	2,8	2,1	3/3	3,65				
M 4,5	0,5	70	13	8	3,5	2,7	3/3	4				
M 5	0,5	70	13	8	3,5	2,7	3/3	4,5				
M 5,5	0,5	80	15	7	4	3	3/3	5				
M 6	0,75	80	15	10	4,5	3,4	3/3	5,2	■	■	■	■
M 6	0,5	80	15	10	4,5	3,4	3/3	5,5				
M 7	0,75	80	15	10	5,5	4,3	3/3	6,2				
M 8	1	90	18	13	6	4,9	3/3	7	■	■	■	■
M 8	0,75	80	15	10	6	4,9	3/3	7,2	■	■	■	■
M 8	0,5	80	15	10	6	4,9	3/3	7,5				
M 9	1	90	18	13	7	5,5	3/3	8				
M 9	0,75	80	18	10	7	5,5	3/3	8,2				
M 10	1,25	100	20	15	7	5,5	3/4	8,8				
M 10	1	90	20	12	7	5,5	3/4	9	■	■	■	■
M 10	0,75	90	20	12	7	5,5	3/4	9,2				
M 11	1	90	20	12	8	6,2	3/4	10				
M 11	0,75	90	20	12	8	6,2	3/4	10,2				
M 12	1,5	100	21	14	9	7	3/4	10,5	■	■	■	■
M 12	1,25	100	21	14	9	7	3/4	10,8				
M 12	1	100	21	14	9	7	3/4	11	■	■	■	■
M 13	1	100	21	15	11	9	3/4	12				
M 14	1,5	100	21	16	11	9	3/4	12,5	■	■	■	■
M 14	1,25	100	21	16	11	9	3/4	12,8				
M 14	1	100	21	16	11	9	3/4	13				
M 15	1,5	100	21	17	12	9	3/4	13,5				
M 15	1	100	21	16	12	9	3/4	14				
M 16	1,5	100	21	16	12	9	3/5	14,5	■	■	■	■
M 16	1	100	21	16	12	9	3/5	15				
M 17	1,5	100	21	17	12	9	3/5	15,5				
M 17	1	100	21	16	12	9	3/5	16				
M 18	2	125	24	20	14	11	3/5	16				
M 18	1,5	110	24	20	14	11	3/5	16,5	■	■	■	■
M 18	1	110	24	20	14	11	3/5	17				
M 20	2	140	30	20	16	12	3/5	18				
M 20	1,5	125	24	20	16	12	3/5	18,5	■	■	■	■
M 20	1	125	24	20	16	12	3/5	19				
M 22	2	140	30	20	18	14,5	3/5	20				
M 22	1,5	125	24	20	18	14,5	3/5	20,5				
M 22	1	125	24	20	18	14,5	3/5	21				
M 24	2	140	26	22	18	14,5	4/5	22				
M 24	1,5	140	26	22	18	14,5	4/5	22,5				
M 24	1	140	26	22	18	14,5	4/5	23				
M 25	2	140	26	22	18	14,5	4/5	23				

■ dodáváme standardně / standard supplies / Standardlieferbar

X.X Doporučené užití / Recommended use / Optimal

X.X Možné použít / Possible use / Geeignet



Skupina obráběného materiálu
Material group / Werkstoffgruppe

3.1; 3.2; 3.3; 8.2; 6.2



3580

3.2; 8.2



3590

3.2; 8.2; 3.1; 3.3; 6.2



4680

3.2



4690

Katalogové číslo / Cat. No. / Kat. Nr.									3580	3590	4680	4690
<p>z = počet drážek / z = number of flutes / z = Nutenzahl</p>									TiCN	OX	TiCN	OX
d ₁	P	l ₁	l ₂	l ₃ R40°	d ₂	a	z / Z _{R40°}	Ø mm				
M 25	1,5	140	26	22	18	14,5	4/5	23,5				
M 26	1,5	140	26	22	18	14,5	4/5	24,5				
M 27	2	140	26	22	20	16	4/5	25				
M 27	1,5	140	26	22	20	16	4/5	25,5				
M 27	1	140	26	22	20	16	4/5	26				
M 28	2	140	26	22	20	16	4/5	26				
M 28	1,5	140	26	22	20	16	4/5	26,5				
M 30	2	150	28	26	22	18	4/5	28				
M 30	1,5	150	28	26	22	18	4/5	28,5				
M 30	1	150	28	26	22	18	4/5	29				
M 32	1,5	150	28	26	22	18	4/5	30,5				
M 33	2	160	30	28	25	20	4/5	31				
M 33	1,5	160	30	28	25	20	4/5	31,5				
M 34	1,5	170	30	28	28	22	4/5	32,5				
M 35	1,5	170	30	30	28	22	4/5	33,5				
M 36	3	200	42	36	28	22	4/5	33				
M 36	2	170	30	28	28	22	4/5	34				
M 36	1,5	170	30	28	28	22	4/5	34,5				

■ dodáváme standardně / standard supplies / Standardlieferbar

X.X Doporučené užití / Recommended use / Optimal
X.X Možno použít / Possible use / Geeignet

STROJNÍ ZÁVITNÍKY

Machine taps / Maschinengewindebohrer



Skupina obráběného materiálu
Material group / Werkstoffgruppe



Katalogové číslo / Cat. No. / Kat. Nr.								3080	3080 IKZ	3130	3130 IKZ
<p>$z = \text{počet drážek} / z = \text{number of flutes} / z = \text{Nutenzahl}$</p>								TiCN	TiCN	TiCN	TiCN
								C 2-3	C 2-3 IKZ	E 1,5	E 1,5 IKZ
d_1	P	l_1	l_2	d_2	a	z	\emptyset mm				
M 3	0,35	56	8	2,2	-	3	2,65				
M 3,5	0,35	56	8	2,5	2,1	3	3,15				
M 4	0,5	63	12	2,8	2,1	3	3,5				
M 4	0,35	63	12	2,8	2,1	3	3,65				
M 4,5	0,5	70	13	3,5	2,7	3	4				
M 5	0,5	70	13	3,5	2,7	3	4,5				
M 5,5	0,5	80	15	4	3	3	5				
M 6	0,75	80	15	4,5	3,4	3	5,2	■	■	■	■
M 6	0,5	80	15	4,5	3,4	3	5,5				
M 7	0,75	80	15	5,5	4,3	3	6,2				
M 8	1	90	18	6	4,9	4	7	■	■	■	■
M 8	0,75	80	15	6	4,9	4	7,2				
M 8	0,5	80	15	6	4,9	4	7,5				
M 9	1	90	18	7	5,5	4	8				
M 9	0,75	80	18	7	5,5	4	8,2				
M 10	1,25	100	20	7	5,5	4	8,8	■	■	■	■
M 10	1	90	20	7	5,5	4	9	■	■	■	■
M 10	0,75	90	20	7	5,5	4	9,2				
M 11	1	90	20	8	6,2	4	10				
M 11	0,75	90	20	8	6,2	4	10,2				
M 12	1,5	100	21	9	7	4	10,5	■	■	■	■
M 12	1,25	100	21	9	7	4	10,8	■	■	■	■
M 12	1	100	21	9	7	4	11	■	■	■	■
M 13	1	100	21	11	9	4	12				
M 14	1,5	100	21	11	9	4	12,5	■	■	■	■
M 14	1,25	100	21	11	9	4	12,8				
M 14	1	100	21	11	9	4	13				
M 15	1,5	100	21	12	9	4	13,5				
M 15	1	100	21	12	9	4	14				
M 16	1,5	100	21	12	9	4	14,5	■		■	
M 16	1	100	21	12	9	4	15				
M 17	1,5	100	21	12	9	4	15,5				
M 17	1	100	21	12	9	4	16				
M 18	2	125	24	14	11	4	16				
M 18	1,5	110	24	14	11	4	16,5	■		■	
M 18	1	110	24	14	11	4	17				
M 20	2	140	30	16	12	4	18				
M 20	1,5	125	24	16	12	4	18,5	■		■	
M 20	1	125	24	16	12	4	19				
M 22	2	140	30	18	14,5	4	20				
M 22	1,5	125	24	18	14,5	4	20,5				
M 22	1	125	24	18	14,5	4	21				
M 24	2	140	26	18	14,5	4	22				
M 24	1,5	140	26	18	14,5	4	22,5				
M 24	1	140	26	18	14,5	4	23				
M 25	2	140	26	18	14,5	4	23				

■ dodáváme standardně / standard supplies / Standardlieferbar

X.X Doporučené užití / Recommended use / Optimal

X.X Možno použít / Possible use / Geeignet



Skupina obráběného materiálu
Material group / Werkstoffgruppe



Katalogové číslo / Cat. No. / Kat. Nr.								3080	3080 IKZ	3130	3130 IKZ
								TiCN	TiCN	TiCN	TiCN
								C 2-3	C 2-3 IKZ	E 1,5	E 1,5 IKZ
d ₁	P	l ₁	l ₂	d ₂	a	z	Ø mm				
M 25	1,5	140	26	18	14,5	4	23,5				
M 26	1,5	140	26	18	14,5	4	24,5				
M 27	2	140	26	20	16	4	25				
M 27	1,5	140	26	20	16	4	25,5				
M 27	1	140	26	20	16	4	26				
M 28	2	140	26	20	16	4	26				
M 28	1,5	140	26	20	16	4	26,5				
M 30	2	150	28	22	18	4	28				
M 30	1,5	150	28	22	18	4	28,5				
M 30	1	150	28	22	18	4	29				
M 32	1,5	150	28	22	18	5	30,5				
M 33	2	160	30	25	20	5	31				
M 33	1,5	160	30	25	20	5	31,5				
M 34	1,5	170	30	28	22	5	32,5				
M 35	1,5	170	30	28	22	5	33,5				
M 36	3	200	42	28	22	5	33				
M 36	2	170	30	28	22	5	34				
M 36	1,5	170	30	28	22	5	34,5				

■ dodáváme standardně / standard supplies / Standardlieferbar

X.X Doporučené užití / Recommended use / Optimal
X.X Možno použít / Possible use / Geeignet

STROJNÍ ZÁVITNÍKY

Machine taps / Maschinengewindebohrer



Skupina obráběného materiálu
Material group / Werkstoffgruppe

10.1; 1.1; 2.1; 6.1; 8.2

8.2; 10.1; 1.1; 2.1; 6.1

1.2; 2.2; 8.1; 1.1; 2.1; 2.3; 6.2; 8.2; 10.1

1.1; 1.2; 2.1; 2.2; 2.3; 6.2; 8.1; 8.2; 10.1



3002



3012



3502



3512

Katalogové číslo / Cat. No. / Kat. Nr.								3002	3012	3502	3512
<p>z = počet drážek / z = number of flutes / z = Nutenzahl</p>								TiN		TiN	
d ₁	N	l ₁	l ₂	d ₂	a	z / z _B	Ø mm				
G 1/16"	28	90	18	6	4,9	3/3	6,8				
G 1/8"	28	90	20	7	5,5	3/3	8,8	■	■	■	■
G 1/4"	19	100	21	11	9	3/3	11,8	■	■	■	■
G 3/8"	19	100	21	12	9	3/3	15,25	■	■	■	■
G 1/2"	14	125	24	16	12	3/3	19	■	■	■	■
G 5/8"	14	125	24	18	14,5	4/4	21	■	■	■	■
G 3/4"	14	140	26	20	16	4/4	24,5	■	■	■	■
G 7/8"	14	150	28	22	18	4/4	28,25	■	■	■	■
G 1"	11	160	30	25	20	4/4	30,75	■	■	■	■
G 1 1/8"	11	170	30	28	22	4/4	35,5	■	■	■	■
G 1 1/4"	11	170	30	32	24	4/4	39,5	■	■	■	■
G 1 3/8"	11	180	32	36	29	6/4	41,8	■	■	■	■
G 1 1/2"	11	190	32	36	29	6/6	45,25	■	■	■	■
G 1 3/4"	11	190	32	40	32	6/6	51,3	■	■	■	■
G 2"	11	220	40	45	35	6/6	57,2	■	■	■	■

■ dodáváme standardně / standard supplies / Standardlieferbar

X.X Doporučené užití / Recommended use / Optimal

X.X Možno použít / Possible use / Geeignet



Skupina obráběného materiálu
Material group / Werkstoffgruppe

2.2; 2.3; 8.1; 6.2; 10.2



4052

2.2; 2.3; 8.1; 6.2; 8.2; 10.2



4062

Katalogové číslo / Cat. No. / Kat. Nr.								4052	4062
<p>z = počet drážek / z = number of flutes / z = Nutenzahl</p>								TiN	
d ₁	N	l ₁	l ₂	d ₂	a	z			
G 1/16"	28	90	13	6	4,9	3	6,8		
G 1/8"	28	90	12	7	5,5	3	8,8	■	■
G 1/4"	19	100	16	11	9	3	11,8	■	■
G 3/8"	19	100	16	12	9	3	15,25	■	■
G 1/2"	14	125	20	16	12	4	19	■	■
G 5/8"	14	125	20	18	14,5	4	21	■	■
G 3/4"	14	140	22	20	16	4	24,5	■	■
G 7/8"	14	150	26	22	18	4	28,25	■	■
G 1"	11	160	30	25	20	4	30,75	■	■
G 1 1/8"	11	170	30	28	22	5	35,5	■	■
G 1 1/4"	11	170	30	32	24	5	39,5	■	■
G 1 3/8"	11	180	32	36	29	5	41,8	■	■
G 1 1/2"	11	190	32	36	29	5	45,25	■	■
G 1 3/4"	11	190	32	40	32	5	51,3		
G 2"	11	220	40	45	35	5	57,2		

■ dodáváme standardně / standard supplies / Standardlieferbar

X.X Doporučené užití / Recommended use / Optimal
X.X Možno použít / Possible use / Geeignet



Skupina obráběného materiálu
Material group / Werkstoffgruppe

3.1; 5.1; 5.2; 9.1; 10.2



3662

3.1; 5.1; 5.2



3692

3.1; 3.3; 5.1; 5.2; 6.2; 9.1; 10.1; 3.2



4262

3.1; 5.1; 5.2



4292

Katalogové číslo / Cat. No. / Kat. Nr.									3662	3692	4262	4292
<p>z = počet drážek / z = number of flutes / z = Nutenzahl</p>									TiN	OX	TiN	OX
d ₁	N	l ₁	l ₂	l _{2R35}	d ₂	a	z / Z _{R35}	Ø mm				
G 1/16"	28	90	18	13	6	4,9	3/3	6,8				
G 1/8"	28	90	20	12	7	5,5	3/3	8,8				
G 1/4"	19	100	21	16	11	9	3/3	11,8				
G 3/8"	19	100	21	16	12	9	3/3	15,25				
G 1/2"	14	125	24	20	16	12	3/4	19				
G 5/8"	14	125	24	20	18	14,5	4/4	21				
G 3/4"	14	140	26	22	20	16	4/4	24,5				
G 7/8"	14	150	28	26	22	18	4/4	28,25				
G 1"	11	160	30	30	25	20	4/4	30,75				
G 1 1/8"	11	170	30	30	28	22	4/5	35,5				
G 1 1/4"	11	170	30	30	32	24	4/5	39,5				
G 1 3/8"	11	180	32	32	36	29	4/5	41,8				
G 1 1/2"	11	190	32	32	36	29	6/5	45,25				

■ dodáváme standardně / standard supplies / Standardlieferbar

X.X Doporučené užití / Recommended use / Optimal

X.X Možno použít / Possible use / Geeignet

STROJNÍ ZÁVITNÍKY

Machine taps / Maschinengewindebohrer



Skupina obráběného materiálu
Material group / Werkstoffgruppe

10.1; 1.1; 2.1; 6.1; 8.2



1004

8.2; 10.1; 1.1; 2.1; 6.1



1014

1.2; 2.2; 8.1; 1.1; 2.1; 2.3; 6.2; 8.2; 10.1



1504

1.1; 1.2; 2.1; 2.2; 2.3; 6.2; 8.1; 8.2; 10.1



1514

Katalogové číslo / Cat. No. / Kat. Nr.								1004	1014	1504	1514
								TiN		TiN	
d ₁	N	l ₁	l ₂	d ₂	a	z	Ø mm				
No. 5	40	56	9	3,5	2,7	3	2,6	■	■	■	■
No. 6	32	56	11	4	3	3	2,85	■	■	■	■
No. 8	32	63	12	4,5	3,4	3	3,5	■	■	■	■
No. 10	24	70	13	6	4,9	3	3,9	■	■	■	■
No. 12	24	80	15	6	4,9	3	4,5	■	■	■	■
1/4	20	80	15	7	5,5	3	5,2	■	■	■	■
5/16	18	90	18	8	6,2	3	6,6	■	■	■	■
3/8	16	90	20	9	7	3	8	■	■	■	■

■ dodáváme standardně / standard supplies / Standardlieferbar

X.X Doporučené užití / Recommended use / Optimal
X.X Možno použít / Possible use / Geeignet



Skupina obráběného materiálu
Material group / Werkstoffgruppe

10.1; 1.1; 2.1; 6.1; 8.2

8.2; 10.1; 1.1; 2.1; 6.1

1.2; 2.2; 8.1; 1.1; 2.1; 2.3; 6.2; 8.2; 10.1

1.1; 1.2; 2.1; 2.2; 2.3; 6.2; 8.1; 8.2; 10.1



3004



3014



3504



3514

Katalogové číslo / Cat. No. / Kat. Nr.								3004	3014	3504	3514
<p>z = počet drážek / z = number of flutes / z = Nutenzahl</p>								TiN		TiN	
d ₁	N	l ₁	l ₂	d ₂	a	z	Ø mm				
7/16	14	100	20	8	6,2	3	9,4	■	■	■	■
1/2	13	110	23	9	7	3	10,75	■	■	■	■
9/16	12	110	25	11	9	3	12,25	■	■	■	■
5/8	11	110	25	12	9	3	13,5	■	■	■	■
3/4	10	125	30	14	11	3	16,5	■	■	■	■
7/8	9	140	30	18	14,5	3	19,5	■	■	■	■
1	8	160	36	18	14,5	3	22,25	■	■	■	■
1 1/8	7	180	40	22	18	4	25	■	■	■	■

■ dodáváme standardně / standard supplies / Standardlieferbar

X.X Doporučené užití / Recommended use / Optimal

X.X Možno použít / Possible use / Geeignet



Skupina obráběného materiálu
Material group / Werkstoffgruppe

2.2; 2.3; 8.1; 6.2; 10.2



2054

2.2; 2.3; 8.1; 6.2; 10.2



4054

2.2; 2.3; 8.1; 6.2; 8.2; 10.2



2064

2.2; 2.3; 8.1; 6.2; 8.2; 10.2



4064

Katalogové číslo / Cat. No. / Kat. Nr.								2054	2064
<p>z = počet drážek / z = number of flutes / z = Nutenzahl</p>									TiN
d ₁	N	l ₁	l ₂	d ₂	a	z	Ø mm		
No. 5	40	56	5	3,5	2,7	3	2,6	■	■
No. 6	32	56	7	4	3	3	2,85	■	■
No. 8	32	63	7	4,5	3,4	3	3,5	■	■
No. 10	24	70	8	6	4,9	3	3,9	■	■
No. 12	24	80	10	6	4,9	3	4,5	■	■
1/4	20	80	10	7	5,5	3	5,2	■	■
5/16	18	90	13	8	6,2	3	6,6	■	■
3/8	16	90	15	9	7	3	8	■	■

Katalogové číslo / Cat. No. / Kat. Nr.								4054	4064
<p>z = počet drážek / z = number of flutes / z = Nutenzahl</p>									TiN
d ₁	N	l ₁	l ₂	d ₂	a	z	Ø mm		
7/16	14	100	18	8	6,2	3	9,4	■	■
1/2	13	110	20	9	7	3	10,75	■	■
9/16	12	110	20	11	9	3	12,25	■	■
5/8	11	110	20	12	9	3	13,5	■	■
3/4	10	125	25	14	11	4	16,5	■	■
7/8	9	140	25	18	14,5	4	19,5	■	■
1	8	160	30	18	14,5	4	22,25	■	■

■ dodáváme standardně / standard supplies / Standardlieferbar

X.X Doporučené užití / Recommended use / Optimal
X.X Možno použít / Possible use / Geeignet

STROJNÍ ZÁVITNÍKY

Machine taps / Maschinengewindebohrer



Skupina obráběného materiálu
Material group / Werkstoffgruppe

10.1; 1.1; 2.1; 6.1; 8.2

8.2; 10.1; 1.1; 2.1; 6.1

1.2; 2.2; 8.1; 1.1; 2.1; 2.3; 6.2; 8.2; 10.1

1.1; 1.2; 2.1; 2.2; 2.3; 6.2; 8.1; 8.2; 10.1



3005



3015



3505



3515

Katalogové číslo / Cat. No. / Kat. Nr.								3005	3015	3505	3515
<p>z = počet drážek / z = number of flutes / z = Nutenzahl</p>								TiN		TiN	
d ₁	N	l ₁	l ₂	d ₂	a	z	Ø mm				
No. 5	44	56	9	2,2	-	3	2,7	■	■	■	■
No. 6	40	56	11	2,5	2,1	3	3	■	■	■	■
No. 8	36	63	12	2,8	2,1	3	3,5	■	■	■	■
No. 10	32	70	13	3,5	2,7	3	4,1	■	■	■	■
No. 12	28	80	15	4	3	3	4,65	■	■	■	■
1/4	28	80	15	4,5	3,4	3	5,5	■	■	■	■
5/16	24	90	18	6	4,9	3	6,9	■	■	■	■
3/8	24	90	20	7	5,5	3	8,5	■	■	■	■
7/16	20	100	20	8	6,2	3	9,9	■	■	■	■
1/2	20	100	21	9	7	3	11,5	■	■	■	■
9/16	18	100	21	11	9	3	12,9	■	■	■	■
5/8	18	100	21	12	9	3	14,5	■	■	■	■
3/4	16	110	24	14	11	3	17,5	■	■	■	■
7/8	14	125	24	18	14,5	3	20,5	■	■	■	■
1	12	140	26	18	14,5	3	23,25	■	■	■	■
1 1/8	12	150	28	22	18	4	26,5				

■ dodáváme standardně / standard supplies / Standardlieferbar

X.X Doporučené užití / Recommended use / Optimal

X.X Možno použít / Possible use / Geeignet



Skupina obráběného materiálu
Material group / Werkstoffgruppe

2.2; 2.3; 8.1; 6.2; 10.2



4055

2.2; 2.3; 8.1; 6.2; 8.2; 10.2



4065

Katalogové číslo / Cat. No. / Kat. Nr.								4055	4065
									TiN
d ₁	N	l ₁	l ₂	d ₂	a	z			
No. 5	44	56	5	2,2	-	3	2,7	■	■
No. 6	40	56	7	2,5	2,1	3	3	■	■
No. 8	36	63	7	2,8	2,1	3	3,5	■	■
No. 10	32	70	8	3,5	2,7	3	4,1	■	■
No. 12	28	80	10	4	3	3	4,65	■	■
1/4	28	80	10	4,5	3,4	3	5,5	■	■
5/16	24	90	13	6	4,9	3	6,9	■	■
3/8	24	90	15	7	5,5	3	8,5	■	■
7/16	20	100	15	8	6,2	3	9,9	■	■
1/2	20	100	14	9	7	3	11,5	■	■
9/16	18	100	16	11	9	3	12,9	■	■
5/8	18	100	16	12	9	3	14,5	■	■
3/4	16	110	20	14	11	4	17,5	■	■
7/8	14	125	20	18	14,5	4	20,5	■	■
1	12	140	22	18	14,5	4	23,25	■	■

■ dodáváme standardně / standard supplies / Standardlieferbar

X.X Doporučené užití / Recommended use / Optimal
X.X Možno použít / Possible use / Geeignet

STROJNÍ KRÁTKÉ ZÁVITNÍKY

Short machine taps / Kurze Maschinengewindebohrer

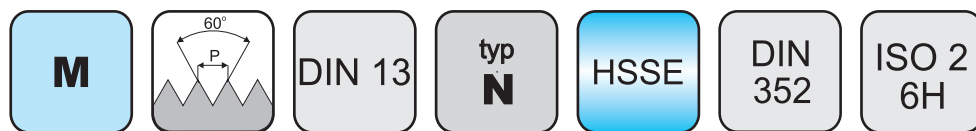

Skupina obráběného materiálu
Material group / Werkstoffgruppe

1.2; 2.2; 8.1; 1.1; 2.1; 2.3; 6.2; 8.2; 10.1

2.2; 2.3; 8.1; 6.2; 10.2

10.1; 2.2



0550



0600



0650

Katalogové číslo / Cat. No. / Kat. Nr.									0550	0600	0650
<p>z = počet drážek / z = number of flutes / z = Nutenzahl</p>											
d ₁	P	l ₁	l ₂	l _{2RSP}	d ₂	a	z	Ø mm			
M 3	0,5	40	9	5	3,5	2,7	3	2,5	■		■
M 4	0,7	45	12	7	4,5	3,4	3	3,3	■		■
M 5	0,8	50	13	8	6	4,9	3	4,2	■		■
M 6	1	56	15	10	6	4,9	3	5	■		■
M 8	1,25	63	18	13	6	4,9	3	6,8	■		■
M 10	1,5	70	20	15	7	5,5	3	8,5	■		■
M 12	1,75	75	23	18	9	7	3	10,2	■		■

■ dodáváme standardně / standard supplies / Standardlieferbar

X.X Doporučené užití / Recommended use / Optimal

X.X Možno použít / Possible use / Geeignet



Skupina obráběného materiálu
Material group / Werkstoffgruppe

11.1; 1.1; 2.1; 2.2; 7.1; 8.1



2910

1.1; 2.2; 7.1; 8.1; 9.1; 1.2; 2.1



2960

Katalogové číslo / Cat. No. / Kat. Nr.						2910	2910	2960	2960	
						TiN	TiN	TiN	TiN	
						ISO 2 6HX	ISO 3 6GX	ISO 2 6HX	ISO 3 6GX	
d_1	P	l_1	l_2	d_2	a	 Viz str. 99 See page No. 99 Siehe Seite Nr. 99	■	■	■	■
M 3	0,5	56	11	3,5	2,7		■	■	■	■
M 3,5	0,6	56	12	4	3		■	■	■	■
M 4	0,7	63	13	4,5	3,4		■	■	■	■
M 5	0,8	70	16	6	4,9		■	■	■	■
M 6	1	80	19	6	4,9		■	■	■	■
M 8	1,25	90	22	8	6,2		■	■	■	■
M 10	1,5	100	24	10	8		■	■	■	■
M 12	1,75	110	28	9	7		■	■	■	■

■ dodáváme standardně / standard supplies / Standardlieferbar

X.X Doporučené užití / Recommended use / Optimal
X.X Možno použít / Possible use / Geeignet

MATICOVÉ ZÁVITNÍKY

Nut taps / Muttergewindebohrer



Skupina obráběného materiálu
Material group / Werkstoffgruppe

1.1; 1.2; 2.1; 2.2; 8.1; 8.2; 10.1; 10.2



5000

Katalogové číslo / Cat. No. / Kat. Nr.								5000	
<p>z = počet drážek / z = number of flutes / z = Nutenzahl</p>									
d ₁	P	l ₁	l ₂	d ₂	a	z		Ø mm	
M 3	0,5	70	22	2,2	-	3		2,5	■
M 4	0,7	90	25	2,8	2,1	3		3,3	■
M 5	0,8	100	28	3,5	2,7	3		4,2	■
M 6	1	110	32	4,5	3,5	3		5	■
M 7	1	110	36	5,5	4,3	3		6	■
M 8	1,25	125	40	6	4,9	3		6,8	■
M 10	1,5	140	45	7	5,5	3		8,5	■
M 11	1,5	160	45	8	6,2	3		9,5	■
M 12	1,75	180	50	9	7	3		10,2	■
M 14	2	200	56	11	9	3		12	■
M 16	2	200	63	12	9	3		14	■
M 18	2,5	220	63	14	11	3		15,5	■
M 20	2,5	250	70	16	12	3		17,5	■

■ dodáváme standardně / standard supplies / Standardlieferbar

X.X Doporučené užití / Recommended use / Optimal

X.X Možno použít / Possible use / Geeignet



Skupina obráběného materiálu
Material group / Werkstoffgruppe

1.1; 1.2; 2.1; 2.2; 2.3; 6.1; 6.2; 8.1; 10.1; 8.2



0200

3 ks v sadě
3 pcs in set
3 Stück im Satz

Katalogové číslo / Cat. No. / Kat. Nr.								0200	0200
<p>z = počet drážek / z = number of flutes / z = Nutenzahl</p>									
d ₁	P	l ₁	l ₂	d ₂	a	z	Ø mm		
M 3	0,5	40	9	3,5	2,7	3	2,5	■	■
M 3,5	0,6	45	11	4	3	3	2,9	■	■
M 4	0,7	45	12	4,5	3,4	3	3,3	■	■
M 4,5	0,75	50	13	6	4,9	3	3,7	■	■
M 5	0,8	50	13	6	4,9	3	4,2	■	■
M 6	1	56	15	6	4,9	3	5	■	■
M 7	1	56	15	6	4,9	3	6	■	■
M 8	1,25	63	18	6	4,9	3	6,8	■	■
M 9	1,25	63	18	7	5,5	3	7,8	■	■
M 10	1,5	70	20	7	5,5	3	8,5	■	■
M 11	1,5	70	20	8	6,2	3	9,5	■	■
M 12	1,75	75	23	9	7	3	10,2	■	■
M 14	2	80	25	11	9	4	12	■	■
M 16	2	80	25	12	9	4	14	■	■
M 18	2,5	95	30	14	11	4	15,5	■	■
M 20	2,5	95	30	16	12	4	17,5	■	■
M 22	2,5	100	30	18	14,5	4	19,5	■	■
M 24	3	110	34	18	14,5	4	21	■	■
M 27	3	110	34	20	16	4	24	■	■
M 30	3,5	125	40	22	18	4	26,5	■	■
M 33	3,5	125	40	25	20	4	29,5	■	■
M 36	4	150	50	28	22	4	32	■	■
M 39	4	150	50	32	24	4	35	■	■
M 42	4,5	150	56	32	24	4	37,5	■	■
M 45	4,5	160	58	36	29	6	40,5	■	■
M 48	5	180	65	36	29	6	43	■	■
M 52	5	180	65	40	32	6	47	■	■

■ dodáváme standardně / standard supplies / Standardlieferbar

X.X Doporučené užití / Recommended use / Optimal
X.X Možno použít / Possible use / Geeignet



Skupina obráběného materiálu
Material group / Werkstoffgruppe

5.1; 5.2; 6.1; 6.2



0290

3 ks v sadě
3 pcs in set
3 Stück im Satz

Katalogové číslo / Cat. No. / Kat. Nr.								0290	
<p>z = počet drážek / z = number of flutes / z = Nutenzahl</p>								OX	
d ₁	P	l ₁	l ₂	d ₂	a	z		Ø mm	
M 3	0,5	40	11	3,5	2,7	3		2,5	■
M 3,5	0,6	45	12	4	3	3		2,9	
M 4	0,7	45	13	4,5	3,4	3		3,3	■
M 4,5	0,75	50	16	6	4,9	3		3,7	
M 5	0,8	50	16	6	4,9	3		4,2	■
M 6	1	56	19	6	4,9	3		5	■
M 7	1	56	19	6	4,9	3		6	
M 8	1,25	63	22	6	4,9	3		6,8	■
M 9	1,25	63	22	7	5,5	3		7,8	
M 10	1,5	70	24	7	5,5	3		8,5	■
M 11	1,5	70	24	8	6,2	3		9,5	
M 12	1,75	75	29	9	7	3		10,2	■
M 14	2	80	30	11	9	4		12	■
M 16	2	80	32	12	9	4		14	■
M 18	2,5	95	40	14	11	4		15,5	■
M 20	2,5	95	40	16	12	4		17,5	■

■ dodáváme standardně / standard supplies / Standardlieferbar

X.X Doporučené užití / Recommended use / Optimal

X.X Možno použít / Possible use / Geeignet



Skupina obráběného materiálu
Material group / Werkstoffgruppe

1.1; 1.2; 2.1; 2.2; 2.3; 6.1; 6.2; 8.1; 10.1; 8.2

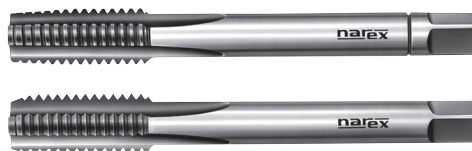

0300

2 ks v sadě
2 pcs in set
2 Stück im Satz

Katalogové číslo / Cat. No. / Kat. Nr.								0300	
<p>z = počet drážek / z = number of flutes / z = Nutenzahl</p>									
d ₁	P	l ₁	l ₂	d ₂	a	z		Ø mm	
M 3	0,35	40	8	3,5	2,7	3			2,65
M 3,5	0,35	45	8	4	3	3			3,15
M 4	0,5	45	9	4,5	3,4	3			3,5
M 4	0,35	45	9	4,5	3,4	3			3,65
M 4,5	0,5	50	10	6	4,9	3			4
M 5	0,5	50	10	6	4,9	3			4,5
M 5,5	0,5	56	11	6	4,9	3			5
M 6	0,75	56	11	6	4,9	3			5,2
M 6	0,5	56	11	6	4,9	3			5,5
M 7	0,75	56	11	6	4,9	3			6,2
M 8	1	63	18	6	4,9	3			7
M 8	0,75	56	14	6	4,9	3			7,2
M 8	0,5	56	14	6	4,9	3			7,5
M 9	1	63	18	7	5,5	3			8
M 9	0,75	56	14	7	5,5	3			8,2
M 10	1,25	70	20	7	5,5	3			8,8
M 10	1	63	18	7	5,5	3			9
M 10	0,75	63	18	7	5,5	3			9,2
M 11	1	63	18	8	6,2	3			10
M 11	0,75	63	18	8	6,2	3			10,2
M 12	1,5	70	20	9	7	3			10,5
M 12	1,25	70	20	9	7	3			10,8
M 12	1	70	18	9	7	3			11
M 13	1	70	18	11	9	3			12
M 14	1,5	70	20	11	9	4			12,5
M 14	1,25	70	20	11	9	4			12,8
M 14	1	70	18	11	9	4			13
M 15	1,5	70	20	12	9	4			13,5
M 15	1	70	18	12	9	4			14
M 16	1,5	70	20	12	9	4			14,5
M 16	1	70	18	12	9	4			15
M 17	1,5	70	20	12	9	4			15,5
M 17	1	70	18	12	9	4			16
M 18	2	80	22	14	11	4			16
M 18	1,5	80	22	14	11	4			16,5
M 18	1	80	18	14	11	4			17
M 20	2	80	22	16	12	4			18
M 20	1,5	80	22	16	12	4			18,5
M 20	1	80	18	16	12	4			19
M 22	2	80	22	18	14,5	4			20
M 22	1,5	80	22	18	14,5	4			20,5
M 22	1	80	18	18	14,5	4			21
M 24	2	90	22	18	14,5	4			22
M 24	1,5	90	22	18	14,5	4			22,5
M 24	1	90	18	18	14,5	4			23
M 25	2	90	22	18	14,5	4			23
M 25	1,5	90	22	18	14,5	4			23,5
M 26	1,5	90	22	18	14,5	4			24,5
M 27	2	90	22	20	16	4			25
M 27	1,5	90	22	20	16	4			25,5

■ dodáváme standardně / standard supplies / Standardlieferbar

X.X Doporučené užití / Recommended use / Optimal
X.X Možno použít / Possible use / Geeignet



Skupina obráběného materiálu
Material group / Werkstoffgruppe

1.1; 1.2; 2.1; 2.2; 2.3; 6.1; 6.2; 8.1; 10.1; 8.2



0300

2 ks v sadě
2 pcs in set
2 Stück im Satz

Katalogové číslo / Cat. No. / Kat. Nr.								0300		
<p>z = počet drážek / z = number of flutes / z = Nutenzahl</p>										
d ₁	P	l ₁	l ₂	d ₂	a	z				
								Ø mm		
M 27	1	90	18	20	16	4	26	■		
M 28	2	90	22	20	16	4	26	■		
M 28	1,5	90	22	20	16	4	26,5	■		
M 30	2	90	22	22	18	4	28	■		
M 30	1,5	90	22	22	18	4	28,5	■		
M 30	1	90	18	22	18	4	29	■		
M 32	1,5	90	22	22	18	4	30,5	■		
M 33	2	100	25	25	20	4	31	■		
M 33	1,5	100	25	25	20	4	31,5	■		
M 34	1,5	100	25	28	22	4	32,5	■		
M 35	1,5	100	25	28	22	4	33,5	■		
M 36	3	125	36	28	22	4	33	■		
M 36	2	125	30	28	22	4	34	■		
M 36	1,5	100	25	28	22	4	34,5	■		
M 38	1,5	100	25	28	22	4	36,5	■		
M 39	3	125	36	32	24	4	36	■		
M 39	2	125	30	32	24	4	37	■		
M 39	1,5	110	25	32	24	4	37,5	■		
M 40	3	125	36	32	24	4	37	■		
M 40	2	125	30	32	24	4	38	■		
M 40	1,5	110	25	32	24	4	38,5	■		
M 42	3	125	36	32	24	4	39	■		
M 42	2	125	30	32	24	4	40	■		
M 42	1,5	110	25	32	24	4	40,5	■		
M 45	3	125	36	36	29	6	42	■		
M 45	2	125	30	36	29	6	43	■		
M 45	1,5	110	25	36	29	6	43,5	■		
M 48	3	140	36	36	29	6	45	■		
M 48	2	140	30	36	29	6	46	■		
M 48	1,5	140	25	36	29	6	46,5	■		
M 50	3	140	36	36	29	6	47	■		
M 50	2	140	30	36	29	6	48	■		
M 50	1,5	140	25	36	29	6	48,5	■		
M 52	3	140	40	40	32	6	49	■		
M 52	2	140	32	40	32	6	50	■		
M 52	1,5	140	25	40	32	6	50,5	■		

■ dodáváme standardně / standard supplies / Standardlieferbar

X.X Doporučené užití / Recommended use / Optimal

X.X Možno použít / Possible use / Geeignet



Skupina obráběného materiálu
Material group / Werkstoffgruppe

1.1; 1.2; 2.1; 2.2; 2.3; 6.1; 6.2; 8.1; 10.1; 8.2



0302

2 ks v sadě
2 pcs in set
2 Stück im Satz

Katalogové číslo / Cat. No. / Kat. Nr.							0302	
<p>z = počet drážek / z = number of flutes / z = Nutenzahl</p>								
d ₁	N	l ₁	l ₂	d ₂	a	z		Ø mm
G 1/16"	28	63	17	6	4,9	3		6,8
G 1/8"	28	63	18	7	5,5	4	■	8,8
G 1/4"	19	70	20	11	9	4	■	11,8
G 3/8"	19	70	20	12	9	4	■	15,25
G 1/2"	14	80	22	16	12	4	■	19
G 5/8"	14	80	22	18	14,5	4	■	21
G 3/4"	14	90	22	20	16	4	■	24,5
G 7/8"	14	90	22	22	18	4	■	28,25
G 1"	11	100	25	25	20	4	■	30,75
G 1 1/8"	11	125	30	28	22	4	■	35,5
G 1 1/4"	11	125	30	32	24	4	■	39,5
G 1 3/8"	11	125	30	36	29	6	■	41,8
G 1 1/2"	11	140	30	36	29	6	■	45,25
G 1 3/4"	11	140	32	40	32	6	■	51,3
G 2"	11	160	36	45	35	6	■	57,2

■ dodáváme standardně / standard supplies / Standardlieferbar

X.X Doporučené užití / Recommended use / Optimal
X.X Možno použít / Possible use / Geeignet



Skupina obráběného materiálu
Material group / Werkstoffgruppe

1.1; 1.2; 2.1; 2.2; 2.3; 6.1; 6.2; 8.1; 10.1; 8.2



0204

3 ks v sadě
3 pcs in set
3 Stück im Satz

Katalogové číslo / Cat. No. / Kat. Nr.								0204	
<p>z = počet drážek / z = number of flutes / z = Nutenzahl</p>									
d ₁	N	l ₁	l ₂	d ₂	a	z			
No. 5	40	40	10	3,5	2,7	3	2,6	■	
No. 6	32	45	11	4	3	3	2,85	■	
No. 8	32	45	12	4,5	3,4	3	3,5	■	
No. 10	24	50	14	6	4,9	3	3,9	■	
No. 12	24	56	16	6	4,9	3	4,5	■	
1/4	20	56	16	6	4,9	3	5,2	■	
5/16	18	63	20	6	4,9	3	6,6	■	
3/8	16	70	22	7	5,5	3	8	■	
7/16	14	70	22	8	6,2	3	9,4	■	
1/2	13	75	25	9	7	3	10,75	■	
9/16	12	80	26	11	9	3	12,25	■	
5/8	11	80	27	12	9	3	13,5	■	
3/4	10	95	32	14	11	4	16,5	■	
7/8	9	100	32	18	14,5	4	19,5	■	
1	8	110	36	18	14,5	4	22,25	■	

■ dodáváme standardně / standard supplies / Standardlieferbar

X.X Doporučené užití / Recommended use / Optimal

X.X Možno použít / Possible use / Geeignet



Skupina obráběného materiálu
Material group / Werkstoffgruppe

1.1; 1.2; 2.1; 2.2; 2.3; 6.1; 6.2; 8.1; 10.1; 8.2



0305
2 ks v sadě
2 pcs in set
2 Stück im Satz

Katalogové číslo / Cat. No. / Kat. Nr.								0305	
<p>z = počet drážek / z = number of flutes / z = Nutenzahl</p>									
d ₁	N	l ₁	l ₂	d ₂	a	z			
							Ø mm		
No. 5	44	40	10	3,5	2,7	3		■	
No. 6	40	45	11	4	3	3		■	
No. 8	36	45	12	4,5	3,4	3		■	
No. 10	32	50	14	6	4,9	3		■	
No. 12	28	56	16	6	4,9	3		■	
1/4	28	56	16	6	4,9	3		■	
5/16	24	63	18	6	4,9	3		■	
3/8	24	63	18	7	5,5	3		■	
7/16	20	70	20	8	6,2	3		■	
1/2	20	70	20	9	7	3		■	
9/16	18	70	20	11	9	3		■	
5/8	18	70	20	12	9	3		■	
3/4	16	80	22	14	11	4		■	
7/8	14	80	22	18	14,5	4		■	
1	12	80	22	18	14,5	4		■	

■ dodáváme standardně / standard supplies / Standardlieferbar

X.X Doporučené užití / Recommended use / Optimal
X.X Možno použít / Possible use / Geeignet

OSTATNÍ ZÁVITNÍKY

Other taps / Sonstige Gewindebohrer

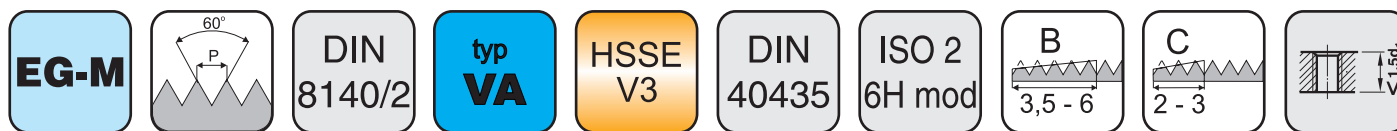

Závrtvníky pro závrtvov  drátov  vlo ky
Taps for wire thread inserts
Gewindebohrer f r Gewindeeins tze

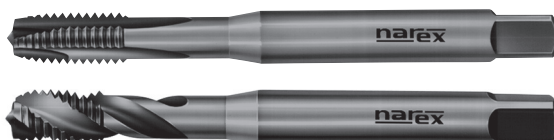

1690 EG, 3690 EG
2290 EG, 4290 EG

Katalogov� číslo / Cat. No. / Kat. Nr.	1690 EG	Katalogov� číslo / Cat. No. / Kat. Nr.	3690 EG
	2290 EG		4290 EG
$z = \text{počet dr�zek} / z = \text{number of flutes} / z = \text{Nutenzahl}$	OX	$z = \text{počet dr�zek} / z = \text{number of flutes} / z = \text{Nutenzahl}$	OX
rozm�r P d ₁ (mm) l ₁ l ₂ l _{2R35} d ₂ a z / Z RSP		rozm�r P d ₁ (mm) l ₁ l ₂ l _{2R35} d ₂ a z / Z RSP	
EG M3 0,5 3,65 63 12 7 4,5 3,4 3/3 3,15	Na popt�vku Upon request Auf Anfrage	EG M10 1,5 11,948 100 21 13 9 7 3/3 10,4	Na popt�vku Upon request Auf Anfrage
EG M3,5 0,6 4,28 70 13 8 6 4,9 3/3 3,7		EG M12 1,75 14,274 110 25 20 11 9 3/3 12,5	
EG M4 0,7 4,91 70 13 8 6 4,9 3/3 4,2		EG M14 2 16,598 110 25 20 12 9 3/4 14,5	
EG M5 0,8 6,04 80 15 10 6 4,9 3/3 5,25		EG M16 2 18,598 125 30 25 14 11 3/4 13	
EG M6 1 7,3 90 18 13 8 6,2 3/3 6,3			
EG M8 1,25 9,624 100 20 15 10 8 3/3 8,4			



Trap zov  maticov  z vrtvníky
Single - finishing trapezoidal taps
Trapez - Einschnitt - Gewindebohrer

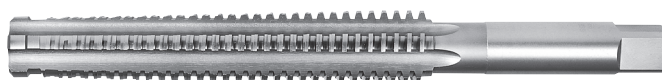

5706

Katalogov� číslo / Cat. No. / Kat. Nr.	5706
$z = \text{počet dr�zek} / z = \text{number of flutes} / z = \text{Nutenzahl}$	
d ₁ P l ₁ l ₂ d ₂ a z	
Tr 10 x 3 140 84 6,3 5 3 7,5	Na popt�vku Upon request Auf Anfrage
Tr 12 x 3 140 84 8 6,3 3 9,25	
Tr 14 x 3 140 84 10 8 3 11,25	
Tr 16 x 4 220 142 11,2 9 3 12,25	
Tr 18 x 4 220 142 12,5 10 3 14,25	
Tr 20 x 4 220 142 14 11,2 3 16,25	
Tr 22 x 5 260 163 16 12,5 3 17,25	
Tr 25 x 5 260 163 18 14 3 20,25	
Tr 28 x 5 260 163 22,4 18 3 23,25	
Tr 32 x 6 310 195 25 20 3 26,25	
Tr 36 x 6 310 195 28 22,4 5 30,25	
Tr 40 x 6 360 227 31,5 25 5 34,5	
Tr 45 x 8 440 275 35,5 28 5 37,5	
Tr 50 x 8 440 275 40 31,5 5 42,5	
Tr 56 x 8 460 282 45 35,5 5 44,5	

OSTATNÍ ZÁVITNÍKY

Other taps / Sonstige Gewindebohrer

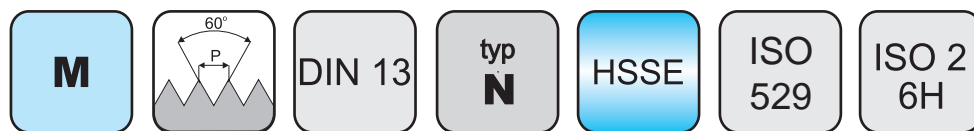



Skupina obráběného materiálu
Material group / Werkstoffgruppe

10.1; 1.1; 2.1; 6.1; 8.2  **6000/7700**

1.2; 2.2; 8.1; 1.1; 2.1; 2.3; 6.2; 8.2; 10.1  **6350/8000**

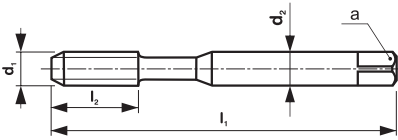
2.2; 2.3; 8.1; 6.2; 10.2  **6750/8350**

Katalogové číslo / Cat. No. / Kat. Nr.								6000/7700	6350/8000	6750/8350
 <p>z = počet drážek / z = number of flutes / z = Nutenzahl</p>								Na poptávku Upon request Auf Anfrage		
d ₁	P	l ₁	l ₂	d ₂	a	z/z RSP	 Ø mm			
M3	0,5	48	11	3,15	2,5	3	2,5			
M4	0,7	53	13	4	3,15	3	3,3			
M5	0,8	58	16	5	4	3	4,2			
M6	1	66	19	6,3	5	3	5			
M8	1,25	72	22	8	6,3	3	6,8			
M10	1,5	80	24	10	8	3	8,5			
M12	1,75	89	29	9	7,1	3	10,2			
M14	2	95	30	11,2	9	3	12			
M16	2	102	32	12,5	10	3/4	14			
M18	2,5	112	37	14	11,2	3/4	15,5			
M20	2,5	112	37	14	11,2	3/4	17,5			
M22	2,5	118	38	16	12,5	3/4	19,5			
M24	3	130	45	18	14	4	21			
M27	3	135	45	20	16	4	24			
M30	3,5	138	48	20	16	4	26,5			



Souprava strojních závitníků a vrtáků v kazetě
Set of machine taps and twist drills
Satz Maschinengewindebohrer und Spiralbohrer in Kasette

C-N-B

Katalogové číslo / Cat. No. / Kat. Nr. **9900**

Souprava obsahuje:
strojní závitníky M3; M4; M5; M6; M8; M10 k.č. 1540 a M12 k.č. 3540
spirálové vrtáky s válcovou stopkou Ø 2,5; 3,3; 4,2; 5; 6,8; 8,5; 10,2

Set containing:
machine taps M3; M4; M5; M6; M8; M10 cat. No. 1540 and M12 cat. No. 3540
twist drills with straight shank Ø 2,5; 3,3; 4,2; 5; 6,8; 8,5; 10,2

Satz bestückt mit:
Maschinengewindebohrer M3; M4; M5; M6; M8; M10 Kat. Nr. 1540 und M12 Kat. Nr. 3540
Spiralbohrer mit Zylinderschaft Ø 2,5; 3,3; 4,2; 5; 6,8; 8,5; 10,2



Souprava strojních závitníků a vrtáků v kazetě
Set of machine taps and twist drills
Satz Maschinengewindebohrer und Spiralbohrer in Kasette

C-N-RSP

Katalogové číslo / Cat. No. / Kat. Nr. **9910**

Souprava obsahuje:
strojní závitníky M3; M4; M5; M6; M8; M10 k.č. 2090 a M12 k.č. 4090
spirálové vrtáky s válcovou stopkou Ø 2,5; 3,3; 4,2; 5; 6,8; 8,5; 10,2

Set containing:
machine taps M3; M4; M5; M6; M8; M10 cat. No. 2090 and M12 cat. No. 4090
twist drills with straight shank Ø 2,5; 3,3; 4,2; 5; 6,8; 8,5; 10,2

Satz bestückt mit:
Maschinengewindebohrer M3; M4; M5; M6; M8; M10 Kat. Nr. 2090 und M12 Kat. Nr. 4090
Spiralbohrer mit Zylinderschaft Ø 2,5; 3,3; 4,2; 5; 6,8; 8,5; 10,2



Souprava strojních závitníků a vrtáků v kazetě
Set of machine taps and twist drills
Satz Maschinengewindebohrer und Spiralbohrer in Kasette

C-VA-B

Katalogové číslo / Cat. No. / Kat. Nr. **9920**

Souprava obsahuje:
strojní závitníky M3; M4; M5; M6; M8; M10 k.č. 1690 a M12 k.č. 3690
spirálové vrtáky s válcovou stopkou Ø 2,5; 3,3; 4,2; 5; 6,8; 8,5; 10,2

Set containing:
machine taps M3; M4; M5; M6; M8; M10 cat. No. 1690 and M12 cat. No. 3690
twist drills with straight shank Ø 2,5; 3,3; 4,2; 5; 6,8; 8,5; 10,2

Satz bestückt mit:
Maschinengewindebohrer M3; M4; M5; M6; M8; M10 Kat. Nr. 1690 und M12 Kat. Nr. 3690
Spiralbohrer mit Zylinderschaft Ø 2,5; 3,3; 4,2; 5; 6,8; 8,5; 10,2





Souprava strojních závitníků a vrtáků v kazetě
 Set of machine taps and twist drills
 Satz Maschinengewindebohrer und Spiralbohrer in Kasette

C-VA-RSP

Katalogové číslo / Cat. No. / Kat. Nr. **9930**

Souprava obsahuje:
 strojní závitníky M3; M4; M5; M6; M8; M10 k.č. 2290 a M12 k.č. 4290
 spirálové vrtáky s válcovou stopkou Ø 2,5; 3,3; 4,2; 5; 6,8; 8,5; 10,2

Set containing:
 machine taps M3; M4; M5; M6; M8; M10 cat. No. 2290 and M12 cat. No. 4290
 twist drills with straight shank Ø 2,5; 3,3; 4,2; 5; 6,8; 8,5; 10,2

Satz bestückt mit:
 Maschinengewindebohrer M3; M4; M5; M6; M8; M10 Kat. Nr. 2290 und M12 Kat. Nr. 4290
 Spiralbohrer mit Zylinderschaft Ø 2,5; 3,3; 4,2; 5; 6,8; 8,5; 10,2



Souprava strojních závitníků a vrtáků v kazetě
 Set of machine taps and twist drills
 Satz Maschinengewindebohrer und Spiralbohrer in Kasette

C-UNI-B

Katalogové číslo / Cat. No. / Kat. Nr. **9940**

Souprava obsahuje:
 strojní závitníky M3; M4; M5; M6; M8; M10 k.č. 1710 a M12 k.č. 3710
 spirálové vrtáky s válcovou stopkou Ø 2,5; 3,3; 4,2; 5; 6,8; 8,5; 10,2

Set containing:
 machine taps M3; M4; M5; M6; M8; M10 cat. No. 1710 and M12 cat. No. 3710
 twist drills with straight shank Ø 2,5; 3,3; 4,2; 5; 6,8; 8,5; 10,2

Satz bestückt mit:
 Maschinengewindebohrer M3; M4; M5; M6; M8; M10 Kat. Nr. 1710 und M12 Kat. Nr. 3710
 Spiralbohrer mit Zylinderschaft Ø 2,5; 3,3; 4,2; 5; 6,8; 8,5; 10,2



Souprava strojních závitníků a vrtáků v kazetě
 Set of machine taps and twist drills
 Satz Maschinengewindebohrer und Spiralbohrer in Kasette

C-UNI-RSP

Katalogové číslo / Cat. No. / Kat. Nr. **9950**

Souprava obsahuje:
 strojní závitníky M3; M4; M5; M6; M8; M10 k.č. 2210 a M12 k.č. 4210
 spirálové vrtáky s válcovou stopkou Ø 2,5; 3,3; 4,2; 5; 6,8; 8,5; 10,2

Set containing:
 machine taps M3; M4; M5; M6; M8; M10 cat. No. 2210 and M12 cat. No. 4210
 twist drills with straight shank Ø 2,5; 3,3; 4,2; 5; 6,8; 8,5; 10,2

Satz bestückt mit:
 Maschinengewindebohrer M3; M4; M5; M6; M8; M10 Kat. Nr. 2210 und M12 Kat. Nr. 4210
 Spiralbohrer mit Zylinderschaft Ø 2,5; 3,3; 4,2; 5; 6,8; 8,5; 10,2





Souprava ručních sadových závitníků a vrtáků v kazetě

Set of hand taps and twist drills

Satz Handgewindebohrer und Spiralbohrer in Kasette

C-N-S

Katalogové číslo / Cat. No. / Kat. Nr. **9960**

Souprava obsahuje:

ruční sadové závitníky M3; M4; M5; M6; M8; M10 a M12 k.č. 0200
spirálové vrtáky s válcovou stopkou Ø 2,5; 3,3; 4,2; 5; 6,8; 8,5; 10,2

Set containing:

hand taps M3; M4; M5; M6; M8; M10 and M12 cat. No. 0200
twist drills with straight shank Ø 2,5; 3,3; 4,2; 5; 6,8; 8,5; 10,2

Satz bestückt mit:

Handgewindebohrer M3; M4; M5; M6; M8; M10 und M12 Kat. Nr. 0200
Spiralbohrer mit Zylinderschaft Ø 2,5; 3,3; 4,2; 5; 6,8; 8,5; 10,2



ZÁVITOVÉ KRUHOVÉ ČELISTI

Circular screwing dies / Schneideisen



Skupina obráběného materiálu
Material group / Werkstoffgruppe

1.1; 1.2; 2.1; 2.2; 2.3; 6.2
6.1; 7.1; 8.1; 8.2; 9.1; 10.1; 10.2



9500
9550

Katalogové číslo / Cat. No. / Kat. Nr.					9500	9550
					Závit lapovaný do M26 Lapped thread up to M26 Geläpptes Gewinde bis M26	S lamačem, závit lapovaný do M26 With spiral point, lapped thread up to M26 Mit Schälanschnitt, geläpptes Gewinde bis M26
d ₁	P	D	E			
M 2	0,4	16	5	■	■	
M 2,2	0,45	16	5			
M 2,5	0,45	16	5	■	■	
M 3	0,5	20	5	■	■	
M 3,5	0,6	20	5	■		
M 4	0,7	20	5	■	■	
M 4,5	0,75	20	5			
M 5	0,8	20	7	■	■	
M 6	1	20	7	■	■	
M 7	1	25	9	■	■	
M 8	1,25	25	9	■	■	
M 9	1,25	25	9	■	■	
M 10	1,5	30	11	■	■	
M 11	1,5	30	11	■	■	
M 12	1,75	38	14	■	■	
M 14	2	38	14	■	■	
M 16	2	45	18	■	■	
M 18	2,5	45	18	■	■	
M 20	2,5	45	18	■	■	
M 22	2,5	55	22	■	■	
M 24	3	55	22	■	■	
M 27	3	65	25	■	■	
M 30	3,5	65	25	■	■	
M 33	3,5	65	25	■	■	
M 36	4	65	25	■	■	
M 39	4	75	30			
M 42	4,5	75	30			
M 45	4,5	90	36			
M 48	5	90	36			
M 52	5	90	36			

■ dodáváme standardně / standard supplies / Standardlieferbar

X.X Doporučené užití / Recommended use / Optimal
X.X Možno použít / Possible use / Geeignet

ZÁVITOVÉ KRUHOVÉ ČELISTI

Circular screwing dies / Schneideisen



Skupina obráběného materiálu
Material group / Werkstoffgruppe

1.1; 1.2; 2.1; 2.2; 2.3; 6.2
6.1; 7.1; 8.1; 8.2; 9.1; 10.1; 10.2



9500
9550

Katalogové číslo / Cat. No. / Kat. Nr.				9500	9550	Katalogové číslo / Cat. No. / Kat. Nr.				9500	9550
				Závit lapovaný Lapped thread Geläpftes Gewinde	S lamačem, závit lapovaný With spiral point, lapped thread Geläpftes Gewinde, mit Schälanschnitt					S lamačem With spiral point Mit Schälanschnitt	
d ₁	P	D	E			d ₁	P	D	E		
M 3	0,35	20	5			M 27	2	65	18		
M 3,5	0,35	20	5			M 27	1,5	65	18		
M 4	0,5	20	5	■		M 27	1	65	18		
M 4	0,35	20	5			M 28	2	65	18		
M 4,5	0,5	20	5			M 28	1,5	65	18		
M 5	0,5	20	5	■		M 30	2	65	18		
M 5,5	0,5	20	5			M 30	1,5	65	18		
M 6	0,75	20	7	■	■	M 30	1	65	18		
M 6	0,5	20	5			M 32	1,5	65	18		
M 7	0,75	25	9	■		M 33	2	65	18		
M 8	1	25	9	■	■	M 33	1,5	65	18		
M 8	0,75	25	9	■	■	M 34	1,5	65	18		
M 8	0,5	25	9			M 35	1,5	65	18		
M 9	1	25	9	■		M 36	3	65	25		
M 9	0,75	25	9			M 36	2	65	18		
M 10	1,25	30	11	■	■	M 36	1,5	65	18		
M 10	1	30	11	■	■	M 38	1,5	75	20		
M 10	0,75	30	11	■		M 39	3	75	30		
M 11	1	30	11			M 39	2	75	20		
M 11	0,75	30	11			M 39	1,5	75	20		
M 12	1,5	38	10	■	■	M 40	3	75	30		
M 12	1,25	38	10	■	■	M 40	2	75	20		
M 12	1	38	10	■	■	M 40	1,5	75	20		
M 13	1	38	10			M 42	3	75	30		
M 14	1,5	38	10	■	■	M 42	2	75	20		
M 14	1,25	38	10	■	■	M 42	1,5	75	20		
M 14	1	38	10	■	■	M 45	3	90	36		
M 15	1,5	38	10			M 45	2	90	22		
M 15	1	38	10			M 45	1,5	90	22		
M 16	1,5	45	14	■	■	M 48	3	90	36		
M 16	1	45	14	■	■	M 48	2	90	22		
M 17	1,5	45	14			M 48	1,5	90	22		
M 17	1	45	14			M 50	3	90	36		
M 18	2	45	14	■	■	M 50	2	90	22		
M 18	1,5	45	14	■	■	M 50	1,5	90	22		
M 18	1	45	14	■		M 52	3	90	36		
M 20	2	45	14			M 52	2	90	22		
M 20	1,5	45	14	■	■	M 52	1,5	90	22		
M 20	1	45	14	■	■						
M 22	2	55	16	■	■						
M 22	1,5	55	16	■	■						
M 22	1	55	16	■	■						
M 24	2	55	16	■	■						
M 24	1,5	55	16	■	■						
M 24	1	55	16	■	■						
M 25	2	55	16								
M 25	1,5	55	16								
M 26	1,5	55	16								

■ dodáváme standardně / standard supplies / Standardlieferbar

X.X Doporučené užití / Recommended use / Optimal

X.X Možno použít / Possible use / Geeignet



Skupina obráběného materiálu
Material group / Werkstoffgruppe

1.1; 1.2; 2.1; 2.2; 2.3; 6.2
6.1; 7.1; 8.1; 8.2; 9.1; 10.1; 10.2



9502

9552

Katalogové číslo / Cat. No. / Kat. Nr.				9502	9552
				Závít lapovaný do G 3/4" Lapped thread up to G 3/4" Geläpptes Gewinde bis G 3/4"	S lamačem, závít lapovaný do G 3/4" With spiral point, lapped thread up to G 3/4" Mit Schälanschnitt, geläpptes Gewinde bis G 3/4"
d ₁	N	D	E		
G 1/16"	28	25	9		
G 1/8"	28	30	11	■	■
G 1/4"	19	38	10	■	■
G 3/8"	19	45	14	■	■
G 1/2"	14	45	14	■	■
G 5/8"	14	55	16	■	■
G 3/4"	14	55	16	■	■
G 7/8"	14	65	18		
G 1"	11	65	18	■	■
G 1 1/8"	11	75	20	■	■
G 1 1/4"	11	75	20	■	■
G 1 1/2"	11	90	22	■	■
G 1 3/4"	11	105	22		
G 2"	11	105	22		

■ dodávame standardně / standard supplies / Standardlieferbar

X.X Doporučené užití / Recommended use / Optimal
X.X Možno použiť / Possible use / Geeignet

ZÁVITOVÉ KRUHOVÉ ČELISTI

Circular screwing dies / Schneideisen

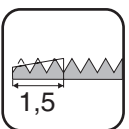
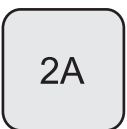
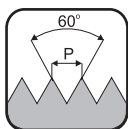

Skupina obráběného materiálu
Material group / Werkstoffgruppe

1.1; 1.2; 2.1; 2.2; 2.3; 6.2
6.1; 7.1; 8.1; 8.2; 9.1; 10.1; 10.2



9504

Katalogové číslo / Cat. No. / Kat. Nr.				9504	
				Závit lapovaný Lapped thread Geläpptes Gewinde	
d ₁	N	D	E		
No. 4	40	16	5		
No. 5	40	20	5		
No. 6	32	20	7		
No. 8	32	20	7	■	
No. 10	24	20	7	■	
No. 12	24	20	7	■	
1/4	20	20	7	■	
5/16	18	25	9	■	
3/8	16	30	11	■	
7/16	14	30	11	■	
1/2	13	38	14	■	
9/16	12	38	14	■	
5/8	11	45	18	■	
3/4	10	45	18	■	
7/8	9	55	22	■	
1	8	55	22	■	

■ dodáváme standardně / standard supplies / Standardlieferbar

X.X Doporučené užití / Recommended use / Optimal

X.X Možno použít / Possible use / Geeignet

ZÁVITOVÉ KRUHOVÉ ČELISTI

Circular screwing dies / Schneideisen



Skupina obráběného materiálu
Material group / Werkstoffgruppe

1.1; 1.2; 2.1; 2.2; 2.3; 6.2
6.1; 7.1; 8.1; 8.2; 9.1; 10.1; 10.2



9505

Katalogové číslo / Cat. No. / Kat. Nr.				9505	
				Závit lapovaný Lapped thread Geläpptes Gewinde	
d ₁	N	D	E		
No. 4	48	16	5		
No. 5	44	20	5		
No. 6	40	20	7		
No. 8	36	20	7	■	
No. 10	32	20	7	■	
No. 12	28	20	7	■	
1/4	28	20	7	■	
5/16	24	25	9	■	
3/8	24	30	11	■	
7/16	20	30	11	■	
1/2	20	38	14	■	
9/16	18	38	14	■	
5/8	18	45	18	■	
3/4	16	45	18	■	
7/8	14	55	22	■	
1	12	55	22	■	

■ dodáváme standardně / standard supplies / Standardlieferbar

X.X Doporučené užití / Recommended use / Optimal
X.X Možno použít / Possible use / Geeignet

ZÁVITOVÉ KRUHOVÉ ČELISTI

Circular screwing dies / Schneideisen

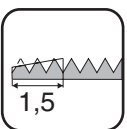
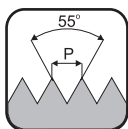

Skupina obráběného materiálu
Material group / Werkstoffgruppe

1.1; 1.2; 2.1; 2.2; 2.3; 6.2
6.1; 7.1; 8.1; 8.2; 9.1; 10.1; 10.2



9501

Katalogové číslo / Cat. No. / Kat. Nr.				9501	
				<p>Závit lapovaný do BSW 1" Lapped thread up to BSW 1" Geläpptes Gewinde bis BSW 1"</p>	
d ₁	N	D	E		
BSW 1/16"	60	16	3,5		
BSW 3/32"	48	16	5		
BSW 1/8"	40	20	5		
BSW 3/16"	24	20	7		
BSW 1/4"	20	20	7		■
BSW 5/16"	18	25	9		■
BSW 3/8"	16	30	11		■
BSW 7/16"	14	30	11		■
BSW 1/2"	12	38	14		■
BSW 9/16"	12	38	14		■
BSW 5/8"	11	45	18		■
BSW 3/4"	10	45	18		■
BSW 7/8"	9	55	22		■
BSW 1"	8	55	22		■
BSW 1 1/4"	7	65	25		
BSW 1 1/2"	6	75	30		
BSW 1 5/8"	5	75	30		
BSW 1 3/4"	5	90	36		
BSW 1 7/8"	4,5	90	36		
BSW 2"	4,5	90	36		

■ dodáváme standardně / standard supplies / Standardlieferbar

X.X Doporučené užití / Recommended use / Optimal

X.X Možno použít / Possible use / Geeignet

Názvosloví

Nomenclature / Nomenklatur

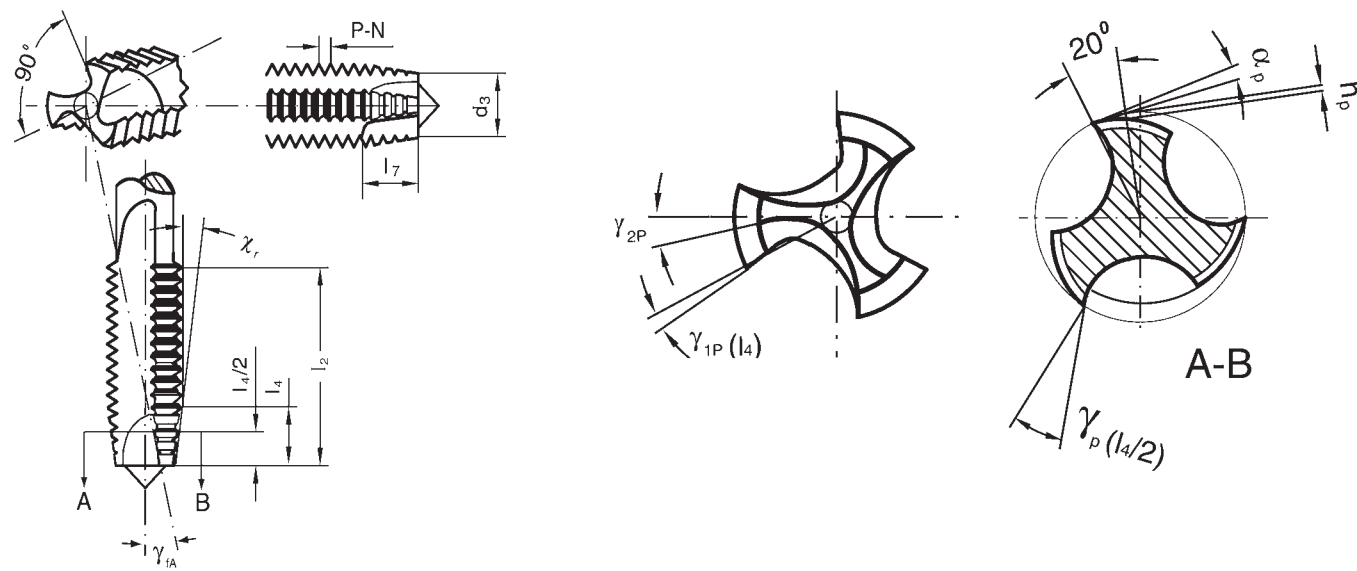
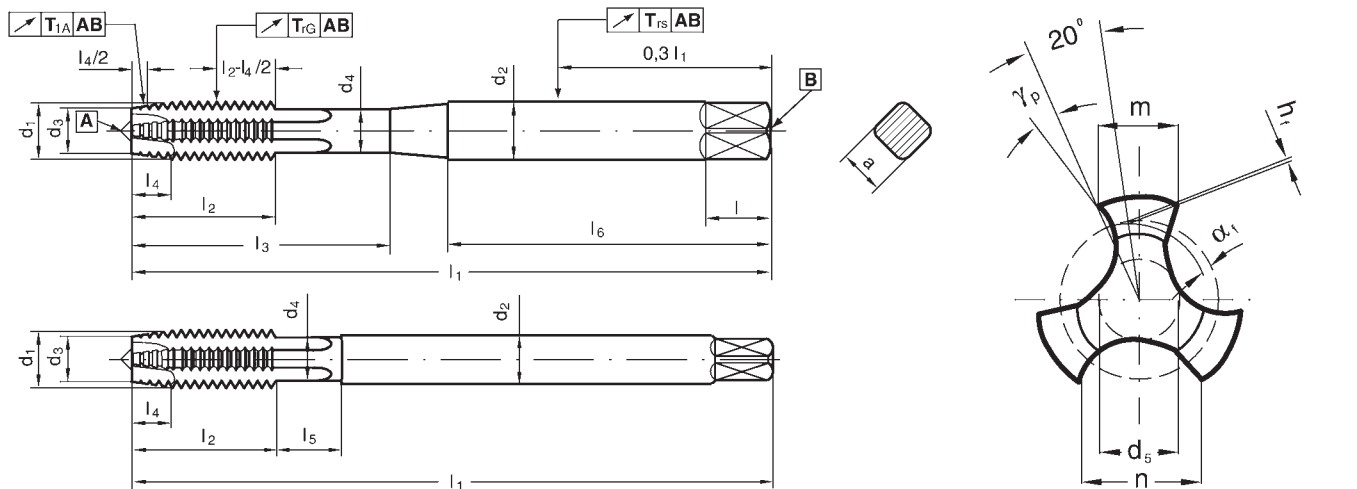

d_1	jmenovitý průměr závitu	nominal tap thread diameter	Nenndurchmesser
d_2	průměr stopky	shank diameter	Schaftdurchmesser
d_3	průměr řezného kužele	lead chamfer diameter	Anschnittdurchmesser
d_4	průměr krčku	neck diameter	Halsdurchmesser
d_5	průměr jádra	core hole diameter	Seelendurchmesser
l_1	celková délka	overall length	Gesamtlänge
l_2	délka závitu	thread length	Gewindelänge
l_3	řezná délka	cutting length	nutzbare Länge
l_4	délka řezného kužele	lead chamfer length	Anschnittlänge
l_5	délka krčku	neck length	Halslänge
l_6	délka stopky	shank length	Schaftlänge
l_7	délka lamače	spiral point length	Schälanschnittlänge
l	délka čtyřhranu	square length	Vierkantlänge
m	šířka žebra	land thickness	Zahnbreite
n	šířka drážky	flute width	Nutenbreite
a	rozměr čtyřhranu	square size	Vierkantmass
P	stoupání závitu v mm	pitch thread in mm	Steigung in mm
N	stoupání závitu v počtu závitů/1"	pitch thread it threads per inch	Steigung in Gangzahl/1"
h_p	podbroušení řezného kužele ve 20°	chamfer relief in 20°	Anschnittinterschliff in 20°
h_r	podbroušení závitu ve 20°	thread relief in 20°	Gewindehinterschliff in 20°
α_p	úhel podbroušení řezného kužele	lead chamfer relief angle	Anschnittfreiwinkel
α_r	úhel podbroušení závitu	thread relief angle	Flankenfreiwinkel
γ_f	úhel šroubové drážky	spiral flute angle	Drallwinkel
γ_p	úhel čela	rake angle	Spanwinkel
γ_{1P}	úhel lamače třísek	spiral point angle	Schälanschnittwinkel
χ_r	úhel řezného kužele	lead chamfer angle	Anschnittwinkel
T_{1A}	úchylna házivosti řezného kužele	limit for lead chamfer	Anschnittschlagabweichung
T_{RG}	úchylna házivosti závitu	limit for thread concentricity	Gewindeschlagabweichung
T_{rS}	úchylna házivosti stopky	limit for shank concentricity	Schaftschlagabweichung

Materiál Material / Material

Skupina Group Gruppe	Legující prvky Alloy component Legierungen	Značka / Sign / Zeichen			Dodavatel Supplier Lieferant
		W. Nr.	DIN	AISI	
HSS	5,0 % Mo	1.3343	S 6-5-2	M2	ERASTEEL Paris, France LATROBE SPECIALITY STEEL COMPANY Latrobe, U.S.A.
HSSE	4,8 % Co	1.3243	S 6-5-2-5	M35	
HSSE V3	3,0 % V	1.3344	S 6-5-3	M3:2	
HSSE PM	3,1 % V	1.3344	S 6-5-3	M3:2	

Řezný kužel Chamfer / Anschnitt

Tvar Form Form	Stoupání Thread Steigung	χ_r	Drážky Flutes Nuten	Převážné použití Recommended application Anwendungsbereich
A	6 ÷ 8	5°	přímé drážky straight flutes gerade Nuten	krátké průchozí otvory short through holes kurze Durchgangsbohrungen
B	3,5 ÷ 6	8°	přímé drážky s lamačem straight flutes with spiral point gerade Nuten mit Schälanschnitt	průchozí otvory v materiálech tvořících střednědlouhou a dlouhou třísku through holes in medium or long chipping materials Durchgangsbohrungen in mittel- bzw. langspanenden Werkstoffen
C	2 ÷ 3	15°	přímé nebo šroubové drážky straight or spiral flutes gerade oder gedrahlte Nuten	neprůchozí nebo průchozí otvory v materiálech tvořících krátkou třísku blind or through holes in short chipping materials Grundlöcher sowie für Durchgangsbohrungen in kurzspanenden Werkstoffen
D	3,5 ÷ 5	8°	přímé nebo šroubové drážky straight or spiral flutes gerade oder gedrahlte Nuten	neprůchozí otvory s možností dlouhého výběhu závitu nebo průchozí otvory blind holes with thread exit or through holes Grundlöcher mit langem Gewinde-Auslauf sowie für Durchgangsbohrungen
E	1,5 ÷ 2	23°	přímé nebo šroubové drážky straight or spiral flutes gerade oder gedrahlte Nuten	neprůchozí otvory s velmi krátkým výběhem závitu blind holes with short thread exit Grundlöcher mit sehr kurzem Gewinde-Auslauf

Velikost podbroušení řezného kužele je závislá na obráběném materiálu. Ovlivňuje stálost rozměrů řezaného závitu.

Všeobecně platí pro úhel hřbetu řezného kužele rozsah $\alpha_p = 1^\circ$ až 5° .

Úhel hřbetu řezného kužele je měřený na poloviční délce řezného kužele ($l_4/2$).

Depends on material of the workpiece and influences on size of the cut thread and it is measured at the middle of the lead chamfer.

$\alpha_p = 1^\circ$ to 5° .

Der Hinterschliff des Anschnittes ist eine werkstoffabhängige Grösse, welche die Masshaltigkeit des geschnittenen Gewindes beeinflusst.

Im Allgemeinen gilt für den Anschnitt-Rückenfreiwinkel der Bereich $\alpha_p = 1^\circ$ bis 5° .

Der Anschnitt-Rückfreiwinkel wird an der halben Anschnitlänge ($l_4/2$) gemessen.

U tvaru řezného kužele B (závitníky s přímou drážkou a lamačem třísek) je úhel lamače třísek γ_{fa} v podstatě závislý na poměru stoupání závitu k průměru jakož i na řezné geometrii závitníku.

Zpravidla platí rozsah $\gamma_{fa} = 8^\circ$ až 18° .

Část závitníku za lamačem třísek má přímé drážky.

Úhel lamače třísek je měřený na poloviční délce řezného kužele ($l_4/2$)

The angle of lead chamfer form B depends mainly on the proportion of the pitch to the thread diameter, as well as the tap cutting geometry and it is measured at the middle of the lead chamfer $l_4/2$.

$\gamma_{fa} = 8^\circ$ to 18° .

Bei Anschnitt-Form B (Schälanschnitt) ist der Schälanschnittwinkel γ_{fa} im wesentlichen vom Verhältnis der Steigung zum Durchmesser sowie von der Schneidengeometrie des Gewindebohrers abhängig.

In der Regel gilt der Bereich $\gamma_{fa} = 8^\circ$ bis 18°

Der an den Schälanschnitt anschliessende Teil des Gewindebohrers ist geradegenutet.

Der Schälanschnittwinkel γ_{fa} wird an der halben Anschnitlänge ($l_4/2$) gemessen.

Úhel čela

Rake angle / Spanwinkel

Úhel čela γ_p dle volby výrobce nebo dle dohody.

Kontrolní bod úhlu čela γ_p je u tvarů řezných kuželů A, C, D a E na prvním stoupání závitu.

Kontrolní bod úhlu čela γ_p je u tvarů řezného kužele B na poloviční délce řezného kužele $l_4/2$.

According to manufacturer or common agreement.

It is measured at the first full thread on all taps with lead chamfer forms A, C, D and E.

With lead chamfer form B it is measured at the middle of lead chamfer $l_4/2$

Spanwinkel γ_p nach Wahl des Herstellers oder nach Vereinbarung.

Messstelle des Spanwinkels γ_p ist bei den Anschnitt-Formen A, C, D, und E, am ersten Gewindegang.

Messstelle des Spanwinkels γ_p ist bei den Anschnitt-Formen B (Schälanschnitt) an der halben Anschnittlänge ($l_4/2$).

Šroubovice

Spiral flute / Drall

Zkratka Sign Kurzzeichen	Úhel šroubovice γ_f Spiral flute angle γ_f Seitenspanwinkel γ_f		Směr šroubové drážky Spiral flute sense Drallrichtung	Obrázek Drawing Bild	Tvar řezného kužele Chamfer form Anschnittform
	min.	max.			
L15	- 10°	- 20°	levá šroubová drážka left hand spiral flutes links gedallte Nuten		D
-	-	-	přímá drážka straight flutes gerade Nuten		A, C, D, E
-	Viz úhel lamače třísek see spiral point angle siehe Schälanschnittwinkel		přímá drážka s lamačem straight flutes with spiral point gerade Nuten mit Schälanschnitt		B
R15	+ 10°	+ 20°	pravá šroubová drážka right hand spiral flutes rechts gedallte Nuten		C, E
R25	+ 20°	+ 30°			
R35	+ 30°	+ 40°			
R45	+ 40°	+ 50°			

Při volbě velikosti úhlu a směru šroubovice γ_f je nutno brát v úvahu druh otvoru (např. neprůchozí otvor, průchozí otvor, hloubka otvoru), průměr závitu, obráběný materiál a druh závitu (pravý nebo levý závit).

Pro tvary řezných kuželů A, C, D a E je v tabulce zkratkou uveden směr šroubovice i velikost a hodnoty úhlů šroubovice γ_f jakož i jejich použití.

Tabulka platí pro pravý závit. Pro levý závit platí opačný směr šroubovice, např. v posledním řádku levá šroubovice s označením L 45 místo pravé šroubovice s označením R 45.

Zkratku pro směr šroubovice a její velikost je nutné v označování závitníků se šroubovými drážkami uvádět.

Skutečný úhel šroubovice γ_f při jmenovitém průměru d_1 a stoupání šroubovice P_f je dán následujícím vzorcem:

$$\gamma_f = \arctg \frac{\pi d_1}{P_f}$$

At selecting the value and direction it must be considered the type of hole (blind hole, through hole etc.), thread diameter and type of thread (left or right). For lead chamfer form A, C, D and E the flute direction is indicated, its angle as well as its use, in table.

$$\gamma_f = \arctg \frac{\pi d_1}{P_f}$$

Bei der Wahl der Grösse und Richtung des Seitenspanwinkels γ_f sind Bohrungsart (z.B. Grundloch, Durchgangsbohrung, Bohrungstiefe), der Gewindedurchmesser, der zu bearbeitende Werkstoff und die Gewindeart (Rechts- oder Linksgewinde) zu berücksichtigen.

Für die Anschnitt-Formen A, C, D und E sind Drallrichtung und -grösse mit den entsprechenden Kurzzeichen und den Werten des Seitenspanwinkels γ_f sowie deren Anwendung in Tabelle aufgeführt.

Die Tabelle gilt für Rechtsgewinde. Für Linksgewinde gilt die entgegengesetzte Drallrichtung, z.B. in der letzten Zeile Linksdraht mit Kurzzeichen L 45 anstatt Rechtsdraht mit Kurzzeichen R 45.

Das Kurzzeichen für Drallrichtung und -grösse ist in der Bezeichnung der drallgenuteten Gewindebohrer anzugeben.

Der Ist-Seitenspanwinkel γ_f bei gegebenem Nenndurchmesser d_1 und Drallsteigung P_f ergibt sich aus der Gleichung:

$$\gamma_f = \arctan \frac{\pi d_1}{P_f}$$

Velikost stoupání šroubové drážky P_f musí odpovídat hodnotám normální číselné řady R20 (viz DIN 323 - 1).

Přřazení velikosti stoupání ke jmenovitému průměru s ohledem na stanovené mezní hodnoty úhlu šroubovice γ_f v tabulce je dáno na vůli výrobce.

POZNÁMKA: sjednocení velikosti stoupání šroubové drážky P_f přřpřívá ke zlepšení vyměnitelnosti a racionálnímu využití provozních prostředků .

Unification of the spiral flute lead P_f serves for better use of tooling. Its value has to be the line values of normal numbers R20 (see DIN 323 - section 1).

Die Steigung der Drallsteigung P_f muss den Werten der Normzahlreihe R20 (siehe DIN 323-1) entsprechen.

Die Zuordnung der Steigung zum Nenndurchmesser ist unter Berücksichtigung der in der Tabelle festgelegten Grenzwerte des Seitenspanwinkels γ_f dem Herstellerfreigestellt.

ANMERKUNG: Die Vereinheitlichung der Steigung P_f dient der Verbesserung der Austauschbarkeit und der rationellen Nutzung von Betriebsmitteln.

Středění

Centering points / Zentrierung

M3 ÷ M6	DIN 371
M3 ÷ M6	DIN 376
M3 ÷ M6	DIN 374
M3 ÷ M6	DIN 352
M3 ÷ M6	DIN 2181
M3 ÷ M6	DIN 357
M3 ÷ M10	DIN 2174



plný hrot
full external center
Vollspitze

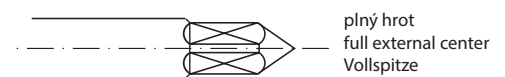

plný hrot
full external center
Vollspitze

M8; M10	DIN 371
M12	DIN 376



osazený hrot
reduced external center
Abgesetzte Spitze

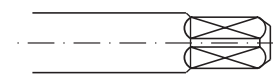

fasetové středění
chamfer centering
Fasenzentrierung

M7; M9	DIN 371
M7 ÷ M10	DIN 376
≥ M14	DIN 376
≥ M7	DIN 374
≥ M7	DIN 352
≥ M7	DIN 2181
≥ M7	DIN 357
≥ M12	DIN 2174



středící otvor
internal center
Zentrierbohrung

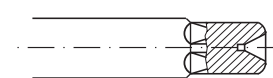

středící otvor
internal center
Zentrierbohrung

Povrchové úpravy a povlaky

Surface treatments and coatings / Oberflächenbehandlungen und Beschichtungen

TiN

Nitrid titanu / Titanium nitride / Titanitrid

Zlatožlutá barva / Gold colour / Goldgelbfarbe

V PVD procesu je při 500 °C dosahován povlak o tloušťce 2-4 μm a mikrotvrdosti 2300 HV. Tento povlak má dobré kluzné vlastnosti a účinně zvyšuje odolnost povrchu nástroje proti abrazivnímu a adheznímu opotřebení. Tento jednovrstvý povlak lze použít až do teploty 600 °C.

In a PVD process (500 °C) a coating thickness of 2-4 μm can be realised. The hardness of approx. 2300 HV, the good sliding properties and the coating adhesion yield considerable tool life increase. This mono-layer coating will remain resistant up to approx. 600 °C.

Im PVD-Verfahren (500 °C) werden Schichtdicken von 2-4 μm erreicht. Die Härte von ca. 2300 HV, gute Gleiteigenschaften und Schichthaftung bringen erhebliche Standwertverbesserungen. Diese Monolayer-Schicht bleibt bis ca. 600 °C stabil.

TiCN

Karbonitrid titanu / Titanium carbonitride / Titancarbonitrid

Modrošedá barva / Blue-grey colour / Blaugraufarbe

V PVD procesu je při 500 °C dosahován povlak o tloušťce 2-4 μm a mikrotvrdosti 3000 HV. Tento povlak je vysoce odolný proti opotřebení. Nízký součinitel tření chrání před vznikem studených svarů. Tento vícevrstvý gradovaný povlak lze použít až do teploty 400 °C.

In a PVD process (500 °C) a coating thickness of 2-4 μm can be realised. The hardness is approx. 3000 HV. The TiCN coating will resist up to approx. 400 °C.

Im PVD-Verfahren (500 °C) werden Schichtdicken von 2-4 μm erreicht. Die Härte beträgt hier ca. 3000 HV. Die TiCN-Schicht bleibt bis ca. 400 °C stabil.

FNT

Balinit® Futura Nano Top

Fialovošedá barva / Violet-grey colour / Violetgraufarbe

V PVD procesu je při 500 °C dosahován povlak o tloušťce 3-5 μm a mikrotvrdosti 3300 HV. Optimalizovaný poměr tvrdosti a vnitřního pnutí vrstvy povlaku zvyšuje stabilitu řezných hran nástrojů. Vynikající tepelná a chemická odolnost spolu s vynikajícími kluznými vlastnostmi umožňují zvyšování výkonu u vysoce zatěžovaných operací. Tento nanostrukturovaný povlak lze použít až do teploty 900 °C.

In a PVD process (500 °C) a coating thickness of 3-5 μm can be realised. Optimised hardness/residual compressive stress ratio, outstanding fidelity of edge geometry, excellent coating adhesion, uniform wear behaviour, better sliding properties due to higher surface quality, greater thermal and chemical resistance, greater wear resistance. The hardness is approx. 3300 HV. The Balinit® Futura Nano Top coating will resist up to approx. 900 °C.

Im PVD-Verfahren (500 °C) werden Schichtdicken von 3-5 μm erreicht. Die Härte beträgt hier ca. 3300 HV. Optimiertes Verhältniss Härte/Druckeigenspannung. Exzellente Schichthaftung und gleichmässiges Verschleissverhalten reduziert Werkzeugkosten und ermöglicht ein breites Anwendungsfeld für höchste Leistungsanforderung. Diese Beschichtung bleibt bis ca. 900°C stabil.

HL

Balinit® Hardlube

Tmavošedá barva / Dark grey colour / Dunkelgraufarbe

V PVD procesu je při 500 °C dosahován povlak o tloušťce 3-5 μm a mikrotvrdosti 3300 HV. Vysoká tvrdost a tepelná odolnost vrstvy TiAlN chrání řezné plochy účinně proti opotřebení, zatímco vynikající kluzné a mazací vlastnosti vrstvy WC/C zajišťují hladký odvod třísek. Výsledkem je vyšší výrobní jistota díky spolehlivému, reprodukovatelnému chování při použití. Tento vícevrstvý lamelární povlak lze použít až do teploty 800 °C.

In a PVD process (500 °C) a coating thickness of 3-5 μm can be realised. Optimised hardness/residual compressive stress ratio, outstanding fidelity of edge geometry, excellent coating adhesion, uniform wear behaviour, better sliding properties due to higher surface quality, greater thermal and chemical resistance, greater wear resistance of the TiAlN layers. Excellent low friction coefficient of the WC/C coating assure uniform chip extraction. The hardness is approx. 3300 HV. The Balinit® Hardlube coating will resist up to approx. 800 °C.

Im PVD-Verfahren (500 °C) werden Schichtdicken von 3-5 μm erreicht. Die Härte beträgt hier ca. 3000 HV. Balinit® Hardlube kombiniert einzigartig die Vorteile einer extrem harten und temperaturfesten TiAlN-Schicht mit den Gleit- und Schmiereigenschaften einer WC/C-Schicht. Sie sorgen so bei Trocken- und bei Nassbearbeitung für eine gleichmässig gute Spanbildung und reibungslosen Spanfluss. Die Balinit® Hardlube Beschichtung bleibt bis 800°C stabil.

ALS

AluSpeed

Světlešedá barva / Light grey colour / Hellgraufarbe

TiB2 - vysoce pevný jednovrstvý povlak s vysokou mikrotvrdostí - vrstva 4 μm s mikrotvrdostí 4.000HV [HV0,05]. Samolubrikační schopnosti s vysokou odolností proti studeným svárům, velmi hladký povrch pro vynikající odvod třísky v drážce nástroje při velmi nízkém tření.

Vhodný pro obrábění hliníku, mědi a titanu (a jejich slitin). Vhodný pro hliníkové slitiny s obsahem křemíku do 10%.

TiB2 - high toughness monolayer coating at very high hardness - by thickness of 4 μm hardness 4.000HV [HV0,05] . Self-lubricating properties with low affinity to cold welding, extremely smooth surface for almost frictionless chip removal in the flute. Very well suited for machining aluminium, copper and titanium (alloys). AlSi alloys with a silicone content up to 10%.

TiB2 - Bei einer Schichtdicke von 4 μm erzielt die Beschichtung eine hohe Zähigkeit bei einer sehr grossen Mikrohärtigkeit von 4.000HV [HV0,05]. Die silbergraue Beschichtung hat Selbstschmiereigenschaften und verhindert durch seine Affinität zum Aluminium in besonderem Maße die Aufbauschneidenbildung. Die extrem glatte Oberfläche verringert die Reibung an den Führungsfasen und erleichtert die Spanabfuhr. Hieraus resultiert eine hohe Oberflächengüte.

Die Beschichtung wurde speziell für die Hochleistungszerspanung von Aluminium und AlSi-Legierungen bis zu einem Si-Anteil von 10%, Kupfer, Titan und Titanlegierungen entwickelt.

OX

Oxidace / Oxidation / Oxidieren

Tmavošedá barva / Dark grey colour / Dunkelgraufarbe

Při chemicko-tepelném procesu ve speciálním zařízení je na povrchu zahřátých nástrojů působením suché páry a tlaku vytvářena vrstva oxidu železa. Tato vrstva oxidu zvyšuje otěrvzdornost ostří, zvyšuje odolnost proti korozi, zlepšuje mazání nástroje.

In a special installation, the tools are exposed to hot steam. This leads to the formation of a dark oxide layer on the tool surface. This oxide layer protects the surface, and acts as a good carrier of lubricants. Cold welding which occurs especially with low-carbon soft steels can be prevented in this way.

In einer Anlage wird den Werkzeugen Wasserdampf zugeführt. Dadurch bildet sich auf der Werkzeugoberfläche eine dunkle Oxidschicht. Diese Oxidschicht bewirkt einen Schutz der Oberfläche. Sie ist ein guter Träger von Schmierstoffen. Kaltschweissungen, wie sie besonderes bei kohlenstoffarmen weichen Stählen auftreten werden vermieden.

PŘEHLED TYPŮ ZÁVITŮ

Threads - general index / Gewinde - Generalindex

Závity podle normy DIN

Threads acc. to DIN Standard / Gewinde nach DIN - Normen

Profil Profile Profil	Symbol	Popis Description Beschreibung	Označení Indication Abkürzung	Norma Standard Norm	Použití Application Anwendung
	M	Metrický ISO závit ISO Metric coarse thread Metrisches ISO - Gewinde	M 0,8	DIN 14 Part 1 ÷ 4	Hodinářství a jemná mechanika For watches and fine mechanic Für Uhren und Feinwerktechnik
			M 30	DIN 13 Part 1	Všeobecné (pro běžné závity) General (Thread normal) Allgemein (Regelgewinde)
			M 20 x 1 M 30 x 2 - LH	DIN 13 Part 2 ÷ 11	Všeobecné (pro jemná stoupání) General (minor pitch as normal) Allgemein (wenn Steigung des Regelgewindes zu gross)
			DIN 6630 M 64 x 4	DIN 6630	Pro šrouby na sudech Screws on barrel units Aussengewinde für Fassverschraubungen
			LN 9163 M 30 x 2 - 4H 5H	LN 9163	Letecká doprava a vesmírné lety For aeronautic industry Luft- und Raumfahrt
		Metrický závit s velkou vůlí Metric thread with big play Metrisches Gewinde mit grossem Spiel	DIN 2510 M 36	DIN 2510 Part 2	Pro šroubová spojení s pružným dílkem For screws with reduced shank Für Schraubenverbindungen mit Dehnschaft
	EGM	Metrický závit ISO pro závitové drátové vložky ISO metric coarse thread for screw thread insert Metrisches ISO-Regelgewinde für Gewindedrahteinsätze	EGM 20	DIN 8140 Part 2	Pro závitové vložky Thread chamfer for inserts with wire thread Aufnahme-Regelgewinde (EG) für Gewindedrahteinsätze aus Draht, für metrisches IOS-Gewinde nach DIN 8140
	M	Metrický vnější kuželový závit Metric taper external thread Metrisches kegeliges Aussengewinde	DIN 158 M 30 x 2 keg.	DIN 158	Pro uzavírací šrouby a maznice For closing screws and greasers Für Verschlusschrauben und Schmiernippel
			DIN 158 keg. M 30 x 2 kurz		
	MJ	Metrický závit MJ Metric thread MJ Metrisches MJ-Gewinde	MJ 6 x 1 - 4h6h	DIN ISO 5855 Part 1 ÷ 2	Letecká doprava a vesmírné lety For aeronautic industry Luft- und Raumfahrt
			MJ 6 x 1 - 4H6H		
	G	Trubkový závit válcový pro spojení netěsnící v závitech Whitworth pipe straight thread Rohrgewinde für nicht im Gewinde dichtende Verbindungen (zylindrisch)	G 1 1/2 A G 1 1/2 B	ČSN – EN – 180 228 DIN ISO 228 Part 1	Vnější závit pro trubky a trubková spojení External thread for pipes and pipe connections Aussengewinde für Rohre und Rohrverbindungen
			G 1 1/2		Vnitřní závit pro trubky a trubková spojení Internal thread for pipes and pipe connections Innengewinde für Rohre und Rohrverbindungen
	Rp	Trubkové závity válcové vnitřní Whitworth pipe cylindrical internal thread Whitworth-Rohrgewinde, zylindrisches Innengewinde	Rp 1/2	DIN EN 10 226 ISO 7-1	Pro trubkový závit a fitinky For pipe thread and fitting Für Gewinderohre und Fittings
	Rc	Trubkové závity kuželové vnitřní Whitworth pipe taper internal thread Whitworth-Rohrgewinde, kegeliges Innengewinde	Rc 3/4	DIN EN 10 226 ISO 7-1	Pro trubky a trubková spojení For pipes and pipe connections Für Rohre und Rohrverbindungen
	R	Trubkové závity kuželové vnější Whitworth pipe taper external thread Whitworth-Rohrgewinde, kegeliges Aussengewinde	R 1/2	DIN EN 10226 ISO 7-1	Pro trubkový závit a fitinky For pipe thread and fitting Für Gewinderohre und Fittings

PŘEHLED TYPŮ ZÁVITŮ

Threads - general index / Gewinde - Generalindex

Závity podle normy DIN

Threads acc. to DIN Standard / Gewinde nach DIN - Normen

Profil Profile Profil	Symbol	Popis Description Beschreibung	Označení Indication Abkürzung	Norma Standard Norm	Použití Application Anwendung
	Tr	Metrický trapézový závit (jedno nebo vícechodý) Metric trapezoidal thread (one or more thread) Metrisches ISO - Trapezgewinde (ein- und mehrgängig)	Tr 40 x 7	DIN 103 Part 1 ÷ 8	Všeobecné General Allgemein
			Tr 40 x 14 P7		
	S	Metrický pilový závit (jedno nebo vícechodý) Metric buttress thread (one or more thread) Metrisches Sägewinde (ein- und mehrgängig)	S 48 x 8	DIN 513 Part 1 ÷ 3	Všeobecné General Allgemein
			S 40 x 14 P7		
	Rd	Oblý závit (jedno nebo vícechodý) Round parallel thread (one or more threads) Rundgewinde	Rd 40 x 1/6 Rd 40 x 1/3 P1/6	DIN 405 Part 1 ÷ 2	Všeobecné General Allgemein
	E	Elektrozávit Electric thread Elektrogewinde	DIN 40400 - E27	DIN 40400	Pro žárovky a objímky For bulbs and lamp holders Für D-Sicherungen; E14 und E27 auch für Lampensockel und -Fassungen
	Pg	Pancéřový závit Steel conduit thread Stahlpanzerrohrgewinde	DIN 40430 - Pg 21	DIN 40430	Pro elektrotechniku In electrotechnic In der Elektrotechnik
	FG	Závit pro jízdní kola Thread for bicycle Fahrradgewinde	FG 9,5	DIN 79012	Pro jízdní kola For bicycles Für Fahrräder
	Vg	Ventilkový závit Thread for valve Ventilgewinde	DIN 7756 - Vg 12	DIN 7756	Pro ventilkovy pneumatik For valves of pneumatic vehicles Ventile für Fahrzeugbereifungen
	W	Whitworthův kuželový závit Whitworth thread taper Whitworth - Gewinde (kegelig)	DIN 477 - W 28,8 x 1/14 keg	DIN 477 Part 1	Ventily plynových lahví Threads nipple valves of gas bottles In Gasflaschenventilen
			DIN 477 - W 21,8 x 1/14		Kuželový trubkový závit pro plynové lahve Side threads nipple valves gas bottle In Gasflaschenventilen
			W 80 x 1/11	DIN 4668	Pro pojistné ventily plynových lahví Protection hood for gas bottles Gewinde für Sicherheitskappen an Gasflaschen

PŘEHLED TYPŮ ZÁVITŮ

Threads - general index / Gewinde - Generalindex

Závity unifikované

Unified threads / Unified Schraubengewinde

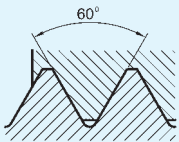
Profil Profile Profil	Symbol	Popis Description Beschreibung	Označení Indication Abkürzung	Norma Standard Norm	Použití Application Anwendung
	UN	Unifikovaný závit Unified thread Unified Schraubengewinde	1/4-20 UNC - 2A 0,250-20 UNC - 2A	ANSI / ASME B1.1-1989	
	UNC				
	UNF				
	UNEF				
	UNS				
	UNJ				
	UNJC				
	UNJF				
	UNJEF				
	EG UNC				
EG UNF					

Závity americké

American threads / Amerikanisches Schraubengewinde

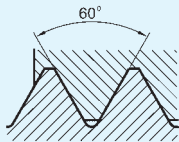
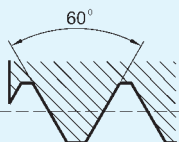
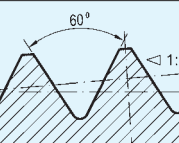
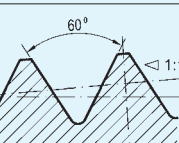
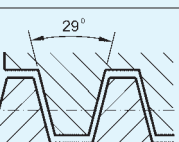
Profil Profile Profil	Symbol	Popis Description Beschreibung	Označení Abreviation Abkürzung	Norma Standard Norm	Použití Application Applikation
	NPSM	Trubkový válcový závit Standard american pipe thread, parallel Rohrgewinde, zylindrisch	1/8-27 NPSM	ANSI / ASME B 1.20.1-1983	
	Dryseal NPSF		1/8-27 NPSF	ANSI B 1.20.3-1976	
	NPT	Trubkový kuželový závit Standard american pipe thread, taper Rohrgewinde, kegelig	3/8-18 NPT	ANSI / ASME B 1.20.1-1983	
	Dryseal NPTF		1/8-27 NPTF-1	ANSI B 1.20.3-1976	
	ACME-G	Trapézový závit American trapezoidal thread Trapezgewinde	13/4 - 4 ACME-G	ANSI B 1.5-1977	

PŘEHLED TYPŮ ZÁVITŮ

Threads - general index / Gewinde - Generalindex

Závity anglické
English threads / Englisches Schraubengewinde

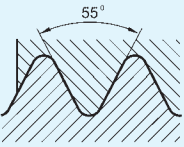
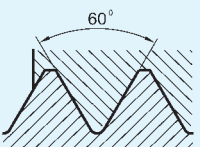
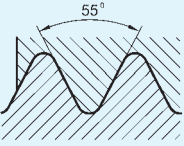
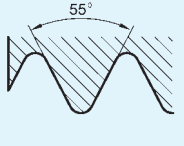
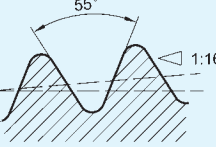
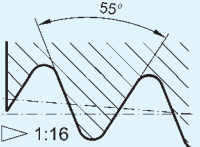
Profil Profile Profil	Symbol	Popis Description Beschreibung	Označení Indication Abkürzung	Norma Standard Norm	Použití Application Anwendung
	BSW		W 1/4-20		
	BSF	Whitworthův závit Standard english thread Whitworth Whitworth-Gewinde	BSF 1/4-26	B.S. 84-1956	
	WHIT		WHIT 1/4-32		
	BSC	Závit pro jízdní kola Britisch standard thread for bicycles Fahrradgewinde		B.S. 811-1950	
	G (BSP)	Trubkový válcový závit Standard english pipe thread Rohrgewinde, zylindrisch	G 1/2 - 14	ISO 228 B.S. 2779-1973	
	Rp (BSPP)	Trubkový válcový závit vnitřní Standard english internal pipe thread Rohrgewinde, zylindrisch	Rp 1/4 - 19	ISO 7-1 B.S. 21-1973	
	R (BSPT)	Trubkový kuželový závit vnější Standard english external pipe thread, taper Rohrgewinde, kegelig	R 1/2 - 14	ISO 7-1 B.S. 21-1985	
	Rc (BSPT)	Trubkový kuželový závit vnitřní Standard english internal pipe thread, taper Rohrgewinde, kegelig	R3 3/8 - 19		

LÍCOVÁNÍ ZÁVITŮ

Thread tolerance / Gewindepassung

Toleranční třídy závitníků pro metrické závity

Tolerance classes of the taps of the metric threads

Toleranzklassen des Gewindebohrers beim Metrischen Gewinde

Toleranční třída závitníku Tolerance class of the tap Toleranzklasse des Gewindebohrers			Použití pro toleranční pole vnitřních závitů Tolerance fields for internal threads Toleranzfeldern für Innengewinde	
Třída Class / Klasse	1	ISO 1	4H	4H 5H
Třída Class / Klasse	2	ISO 2	6H	6H 4G 5G
Třída Class / Klasse	3	ISO 3	6G	7H 8H 6G
			7G	7G 8G

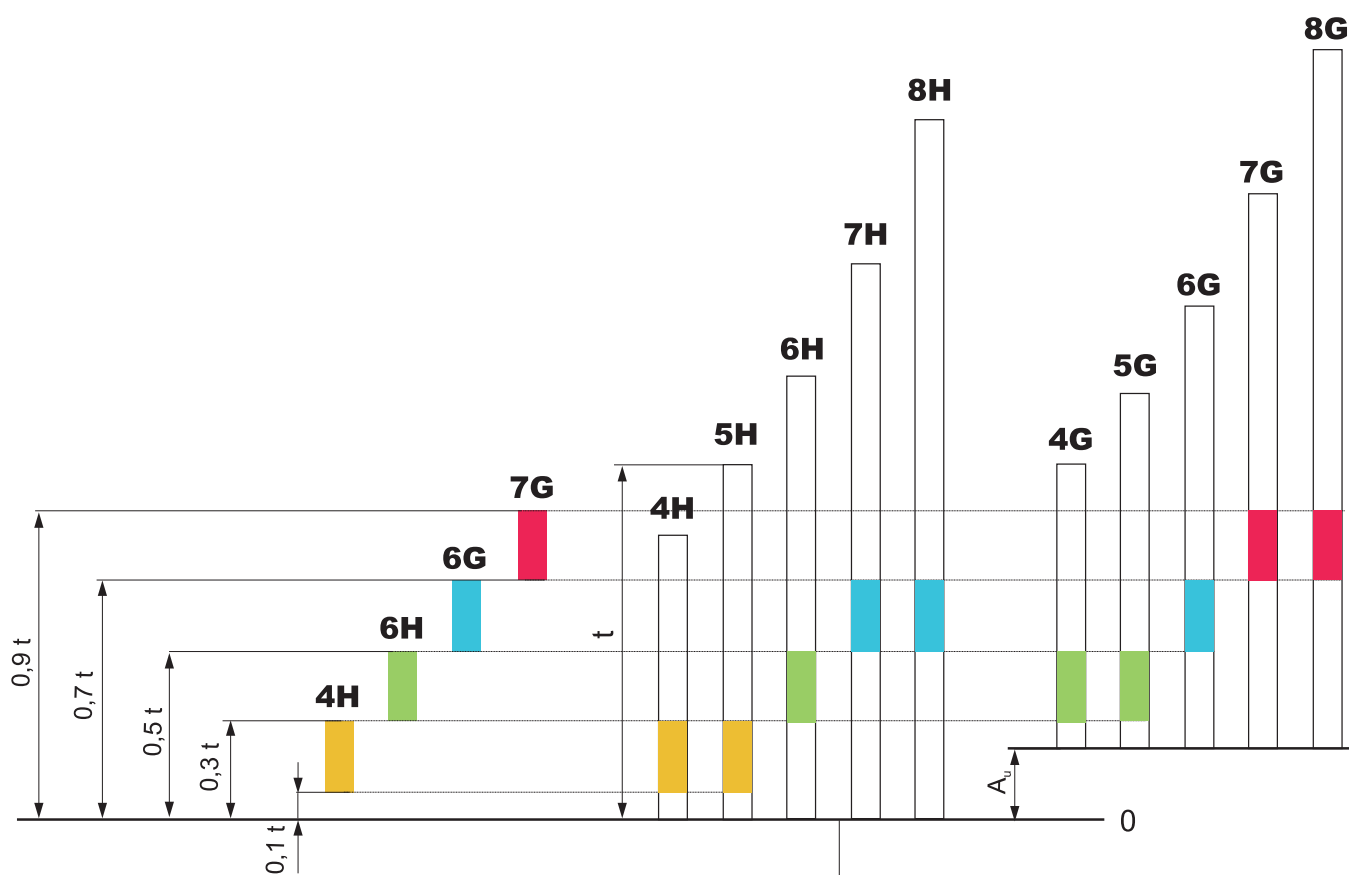

$t = T_{d_2}$ úchylka vnitřního závitu stupně přesnosti 5
tolerance of the internal thread (qual. 5)
Toleranzeinheit des Innengewindes (Qual. 5)

A_u základní úchylka tolerančních polí G
fundamental deviation of tolerance fields G
Grundabmass für Toleranzfelder G

Jmenovitý střední průměr závitu
Nominal pitch diameter (basis)
Nennflankendurchmesser (Basis)

TVÁŘENÍ ZÁVITŮ

Thread forming / Gewindeformen

Tváření vnitřních závitů je jednou z technologií výroby závitů. Závit při něm není řezán, ale beztržkové tváření vytlačováním materiálu. Tato technologie je vhodná pro výrobu závitů do materiálů dobře tvářitelných za studena s minimální tažností 10%.

Výhody tvářeného závitu proti řezanému závitu:

- nevznikají třísky, odpadá nebezpečí jejich vzpříčení v závítovaném otvoru
- lepší kvalita povrchu na bocích vytvářeného závitu
- čistý závit, žádné stopy na povrchu závitu
- rovnoměrná kalibrace závitu
- nepřerušovaný průběh vlákna materiálu a tím zvýšená pevnost šroubového spojení
- větší odolnost nástroje proti lomu a tím i vyšší životnost nástroje
- vyšší tvářecí rychlost zvyšuje produktivitu

Podmínky použití technologie tváření závitu:

- dodržení požadovaného průměru předvrtání otvoru; menší otvor může způsobit zalomení nástroje, větší otvor znamená nedotvářený malý průměr závitu
- dostatečné mazání; při tváření vzniká vysoké tření, proto je doporučeno použití kvalitního mazacího oleje

Thread forming of internal threads is one of the technologies of thread production. This technology could be used for thread production in materials with minimal ductility 10%.

Advantages of formed thread:

- no chips during threading process
- higher surface quality on thread flanks, very clean thread
- uniform calibration of thread
- higher strength of screw connection
- higher mechanical resistance of forming taps – longer tool life
- higher speed = higher productivity

Operating conditions:

- optimal diameter of drilled hole
- sufficient cooling
- sufficient spindle/tap revolutions

Das Formen von Innengewinden gehört zu den modernsten Technologien der Gewindeproduktion. Das Gewinde wird spanlos kaltverformt. Diese Technologie ist für Materialien mit einer Mindestdehnung von 10% geeignet.

Vorteile des Gewindeformens:

- Es entstehen keine Späne, dadurch keine Gefahr des Verklemmens der Späne im Gewinde
- Erhöhte Festigkeit des Gewindes, dadurch stabilere Schraubverbindungen
- Saubere Gewindeoberflächen
- Gleichbleibende Toleranz des Gewindes
- Höhere Standzeiten und bessere Werkzeugbruchsicherheit
- Produktivitätssteigerung durch grössere Schnittgeschwindigkeiten

Voraussetzungen für das effiziente Gewindeformen:

- Einhaltung der vorgeschriebenen Kernlochdurchmesser
- Verwendung von geeigneten Schmiermitteln. Die hohen Kräfte beim Formen des Gewindes bedingen hohe Reibungskräfte am Gewindeformer. Deshalb empfehlen wir die Verwendung von leistungsfähigen Schmierölen mit Hochdruckeigenschaften oder zumindest eine 10%-ige Emulsion.

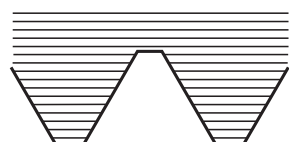

Závit řezaný
Cut thread

Geschnittenes Gewinde

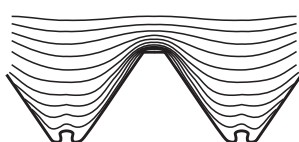

Závit tvářený
Formed thread

Spanlos geformtes Gewinde

DOPORUČENÉ PŘEDVRTÁNÍ OTVORŮ PRO TVÁŘENÍ ZÁVITŮ

Recommended hole diameters for forming of the threads

Empfohlene Vorbohr für das Gewindeformen

Metrický závit ISO - hrubý Metric ISO - coarse thread / Metrisches ISO - Regelgewinde			
Rozměr závitu Thread size Gewinde Abmessung		Předvrtaný otvor - Ø Hole diameter - Ø Vorbohr - Ø	
	P mm	min mm	max mm
M 3	0,5	2,77	2,82
M 3,5	0,6	3,23	3,28
M 4	0,7	3,68	3,73
M 4,5	0,75	4,15	4,21
M 5	0,8	4,63	4,68
M 6	1	5,51	5,59
M 7	1	6,51	6,59
M 8	1,25	7,39	7,48
M 9	1,25	8,39	8,48
M 10	1,5	9,25	9,35
M 11	1,5	10,25	10,35
M 12	1,75	11,12	11,25
M 14	2	13	13,15
M 16	2	15	15,15
M 18	2,5	16,72	16,9
M 20	2,5	18,72	18,9

Trubkový závit Whitworth pipe thread / Withworth-Rohrgewinde			
Rozměr závitu Thread size Gewinde Abmessung		Předvrtaný otvor - Ø Hole diameter - Ø Vorbohr - Ø	
	P/1"	min mm	max mm
G 1/8"	28	9,25	9,32
G 1/4"	19	12,43	12,53
G 3/8"	19	15,94	16,04
G 1/2"	14	19,96	20,1
G 5/8"	14	21,92	22,08
G 3/4"	14	25,45	25,6
G 7/8"	14	29,2	29,35
G 1"	11	31,97	32,15

Metrický závit ISO - jemný Metric ISO - fine thread / Metrisches ISO - Feingewinde			
Rozměr závitu Thread size Gewinde Abmessung		Předvrtaný otvor - Ø Hole diameter - Ø Vorbohr - Ø	
		min mm	max mm
M 3,5 x 0,5		3,27	3,32
M 4 x 0,5		3,77	3,82
M 4,5 x 0,5		4,27	4,32
M 5 x 0,5		4,77	4,82
M 5,5 x 0,5		5,27	5,32
M 6 x 0,5		5,78	5,83
M 6 x 0,75		5,65	5,71
M 7 x 0,75		6,65	6,71
M 8 x 0,75		7,65	7,71
M 9 x 0,75		8,65	8,71
M 10 x 0,75		9,65	9,71
M 11 x 0,75		10,65	10,71
M 8 x 1		7,51	7,59
M 9 x 1		8,51	8,59
M 10 x 1		9,51	9,59
M 11 x 1		10,51	10,59
M 12 x 1		11,52	11,6
M 14 x 1		13,52	13,6
M 15 x 1		14,52	14,6
M 16 x 1		15,52	15,6
M 18 x 1		17,52	17,6
M 20 x 1		19,52	19,6
M 10 x 1,25		9,39	9,48
M 12 x 1,25		11,4	11,49
M 14 x 1,25		13,4	13,49
M 12 x 1,5		11,26	11,36
M 14 x 1,5		13,26	13,36
M 16 x 1,5		15,26	15,36
M 18 x 1,5		17,26	17,36
M 20 x 1,5		19,26	19,36
M 22 x 1,5		21,26	21,36
M 24 x 1,5		23,26	23,38
M 25 x 1,5		24,26	24,38
M 26 x 1,5		25,26	25,38
M 28 x 1,5		27,26	27,38
M 30 x 1,5		29,26	29,38
M 18 x 2		17	17,15
M 20 x 2		19	19,15
M 22 x 2		21	21,15
M 24 x 2		23,01	23,16
M 27 x 2		26,01	26,16
M 30 x 2		29,01	29,16

Uvedené hodnoty je nutné vždy ověřit s ohledem na tažnost tvářeného materiálu.
Check the value in consideration of roll formed material ductility.
Die Angaben mit bezug auf die Dehnfähigkeit des Materials überprüfen

ZÁVITOVÉ TABULKY

Threading charts / Gewindetabellen

M **DIN 13**

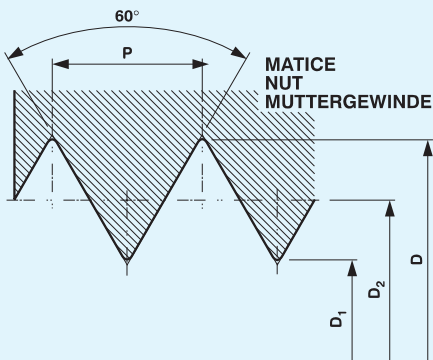

- D velký průměr závitu matice
major diameter of nut thread
Aussendurchmesser des Muttergewindes
- D₂ střední průměr závitu matice
pitch diameter of nut thread
Flankendurchmesser des Muttergewindes
- D₁ malý průměr závitu matice
minor diameter of nut thread
Kerndurchmesser des Muttergewindes
- P stoupání závitu
pitch of thread
Gewindesteigung

d = D

Závit Thread / Gewinde		D _{1 max}			D _{1 min}
d	P	5H	6H	7H	5H, 6H, 7H
M 2	0,40	1,657	1,679	-	1,567
M 2,5	0,45	2,113	2,138	-	2,013
M 3	0,50	2,571	2,599	2,639	2,459
M 3	0,35	2,701	2,721	-	2,621
M 3,5	0,60	2,975	3,010	3,050	2,850
M 3,5	0,35	3,201	3,221	-	3,121
M 4	0,70	3,382	3,422	3,466	3,242
M 4	0,50	3,571	3,599	3,639	3,459
M 4	0,35	3,701	3,722	-	3,622
M 4,5	0,75	3,838	3,878	3,924	3,688
M 4,5	0,50	4,071	4,099	4,139	3,959
M 5	0,80	4,294	4,334	4,384	4,134
M 5	0,50	4,571	4,599	4,639	4,459
M 5,5	0,50	5,071	5,099	5,139	4,959
M 6	1,00	5,107	5,153	5,217	4,917
M 6	0,75	5,338	5,378	5,424	5,188
M 6	0,50	5,570	5,598	5,638	5,458
M 7	1,00	6,107	6,153	6,217	5,917
M 7	0,75	6,338	6,378	6,424	6,188
M 8	1,25	6,859	6,912	6,982	6,647
M 8	1,00	7,107	7,153	7,217	6,917
M 8	0,75	7,338	7,378	7,424	7,188
M 8	0,50	7,570	7,598	7,638	7,458
M 9	1,25	7,859	7,912	7,982	7,647
M 9	1,00	8,107	8,153	8,217	7,917
M 9	0,75	8,338	8,378	8,424	8,188
M 10	1,50	8,612	8,676	8,751	8,376
M 10	1,25	8,859	8,912	8,982	8,647
M 10	1,00	9,107	9,153	9,217	8,917
M 10	0,75	9,338	9,378	9,424	9,188
M 11	1,50	9,612	9,676	9,751	9,376
M 11	1,00	10,107	10,153	10,217	9,917
M 11	0,75	10,338	10,378	10,424	10,188
M 12	1,75	10,371	10,441	10,531	10,106
M 12	1,50	10,612	10,676	10,751	10,376
M 12	1,25	10,859	10,912	10,982	10,647
M 12	1,00	11,107	11,153	11,217	10,917
M 13	1,00	12,108	12,154	12,218	11,918
M 14	2,00	12,135	12,210	12,310	11,835
M 14	1,50	12,612	12,676	12,751	12,376
M 14	1,25	12,859	12,912	12,982	12,647
M 14	1,00	13,107	13,153	13,217	12,917
M 15	1,50	13,612	13,676	13,751	13,376
M 15	1,00	14,107	14,153	14,217	13,917
M 16	2,00	14,135	14,210	14,310	13,835
M 16	1,50	14,612	14,676	14,751	14,376
M 16	1,00	15,107	15,153	15,217	14,917
M 17	1,50	15,612	15,676	15,751	15,376
M 17	1,00	16,107	16,153	16,217	15,917
M 18	2,50	15,649	15,744	15,854	15,294
M 18	2,00	16,135	16,210	16,310	15,835
M 18	1,50	16,612	16,676	16,751	16,376
M 18	1,00	17,107	17,153	17,217	16,917
M 20	2,50	17,649	17,744	17,854	17,294
M 20	2,00	18,135	18,210	18,310	17,835
M 20	1,50	18,612	18,676	18,751	18,376
M 20	1,00	19,107	19,153	19,217	18,917
M 22	2,50	19,649	19,744	19,854	19,294
M 22	2,00	20,135	20,210	20,310	19,835
M 22	1,50	20,612	20,676	20,751	20,376
M 22	1,00	21,107	21,153	21,217	20,917
M 24	3,00	21,152	21,252	21,382	20,752
M 24	2,00	22,135	22,210	22,310	21,835
M 24	1,50	22,612	22,676	22,751	22,376

Závit Thread / Gewinde		D _{1 max}			D _{1 min}
d	P	5H	6H	7H	5H, 6H, 7H
M 24	1,00	23,107	23,153	23,217	22,917
M 25	2,00	23,135	23,210	23,310	22,835
M 25	1,50	23,612	23,676	23,751	23,376
M 26	1,50	24,612	24,676	24,751	24,376
M 27	3,00	24,152	24,252	24,382	23,752
M 27	2,00	25,135	25,210	25,310	24,835
M 27	1,50	25,612	25,676	25,751	25,376
M 27	1,00	26,107	26,153	26,217	25,917
M 28	2,00	26,135	26,210	26,310	25,835
M 28	1,50	26,612	26,676	26,751	26,376
M 30	3,50	26,661	26,771	26,921	26,211
M 30	2,00	28,135	28,210	28,310	27,835
M 30	1,50	28,612	28,676	28,751	28,376
M 30	1,00	29,107	29,153	29,217	28,917
M 32	1,50	30,612	30,676	30,751	30,376
M 33	3,50	29,661	29,771	29,921	29,211
M 33	2,00	31,135	31,210	31,310	30,835
M 33	1,50	31,612	31,676	31,751	31,376
M 34	1,50	32,612	32,676	32,751	32,376
M 35	1,50	33,612	33,676	33,751	33,376
M 36	4,00	32,145	32,270	32,420	31,670
M 36	3,00	33,152	33,252	33,382	32,752
M 36	2,00	34,135	34,210	34,310	33,835
M 36	1,50	34,612	34,676	34,751	34,376
M 38	1,50	36,612	36,676	36,751	36,376
M 39	4,00	35,145	35,270	35,420	34,670
M 39	3,00	36,152	36,252	36,382	35,752
M 39	2,00	37,135	37,210	37,310	36,835
M 39	1,50	37,612	37,676	37,751	37,376
M 40	3,00	37,152	37,252	37,382	36,752
M 40	2,00	38,135	38,210	38,310	37,835
M 40	1,50	38,612	38,676	38,751	38,376
M 42	4,50	37,659	37,799	37,979	37,129
M 42	3,00	39,152	39,252	39,382	38,752
M 42	2,00	40,135	40,210	40,310	39,835
M 42	1,50	40,612	40,676	40,751	40,376
M 45	4,50	40,659	40,799	40,979	40,129
M 45	3,00	42,152	42,252	42,382	41,752
M 45	2,00	43,135	43,210	43,310	42,835
M 45	1,50	43,612	43,676	43,751	43,376
M 48	5,00	43,147	43,297	43,487	42,587
M 48	3,00	45,152	45,252	45,382	44,752
M 48	2,00	46,135	46,210	46,310	45,835
M 48	1,50	46,612	46,676	46,751	46,376
M 50	3,00	47,152	47,252	47,382	46,752
M 50	1,50	48,612	48,676	48,751	48,376
M 52	5,00	47,147	47,297	47,487	46,587
M 52	3,00	49,152	49,252	49,382	48,752
M 52	2,00	50,135	50,210	50,310	49,835
M 52	1,50	50,612	50,676	50,751	50,376
M 55	2,00	53,135	53,210	53,310	53,835
M 55	1,50	53,612	53,676	53,751	53,376
M 56	5,50	50,646	50,796	50,996	50,046
M 56	4,00	52,145	52,270	52,420	51,670
M 56	3,00	53,152	53,252	53,382	52,752
M 56	2,00	54,135	54,210	54,310	53,835
M 56	1,50	54,612	54,676	54,751	54,376
M 58	2,00	56,135	56,210	56,310	55,835
M 58	1,50	56,612	56,676	56,751	56,376
M 60	5,50	54,326	54,401	54,496	54,046
M 60	4,00	56,145	56,270	56,420	55,670
M 60	3,00	57,152	57,252	57,382	56,752
M 60	2,00	58,135	58,210	58,310	57,835
M 60	1,50	58,612	58,676	58,751	58,376

ZÁVITOVÉ TABULKY

Threading charts / Gewindetabellen

UNC

**ANSI
B 1.1**

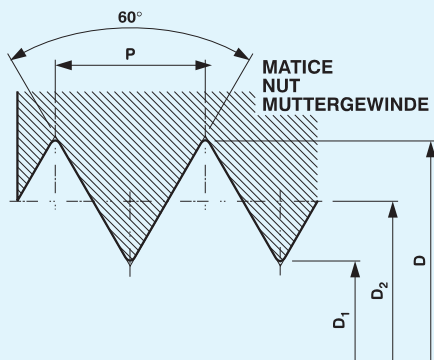

- D velký průměr závitu matice
major diameter of nut thread
Aussendurchmesser des Muttergewindes
- D_2 střední průměr závitu matice
pitch diameter of nut thread
Flankendurchmesser des Muttergewindes
- D_1 malý průměr závitu matice
minor diameter of nut thread
Kerndurchmesser des Muttergewindes
- P stoupání závitu
pitch of thread
Gewindesteigung
- N stoupání závitu v počtu závitů na 1"
pitch thread in threads per inch
Gewindesteigung in Gangzahl/1"

3B Přesné / Fine / Fein
2B Střední / Medium / Mittel
1B Hrubé / Coarse / Grob

$d = D$

d - N	Závit Thread / Gewinde		D_{min}	D_{1min}	D_{1max}	
	d (")	P			3B, 2B, 1B	3B
1 - 64	0,073	0,397	1,854	1,425	1,582	1,582
2 - 56	0,086	0,454	2,184	1,694	4,872	1,872
3 - 48	0,099	0,529	2,515	1,941	2,146	2,146
4 - 40	0,112	0,635	2,845	2,156	2,385	2,385
5 - 40	0,125	0,635	3,175	2,487	2,697	2,697
6 - 32	0,138	0,794	3,505	2,647	2,896	2,896
8 - 32	0,164	0,794	4,166	3,307	3,528	3,531
10 - 24	0,190	1,058	4,826	3,680	3,950	3,962
12 - 24	0,216	1,058	5,486	4,341	4,590	4,597
1/4 - 20	0,250	1,270	6,350	4,976	5,250	5,258
5/16 - 18	0,313	1,411	7,938	6,411	6,680	6,731
3/8 - 16	0,375	1,588	9,525	7,805	8,082	8,153
7/16 - 14	0,438	1,814	11,112	9,149	9,441	9,550
1/2 - 13	0,500	1,954	12,700	10,584	10,881	11,024
9/16 - 12	0,563	2,117	14,288	11,996	12,301	12,446
5/8 - 11	0,625	2,309	15,875	13,376	13,693	13,868
3/4 - 10	0,750	2,540	19,050	16,299	16,624	16,840
7/8 - 9	0,875	2,822	22,225	19,169	19,520	19,761
1 - 8	1,000	3,175	25,400	21,963	22,344	22,606
1 1/8 - 7	1,125	3,629	28,575	24,648	25,082	25,349
1 1/4 - 7	1,250	3,629	31,750	27,823	28,258	28,524
1 3/8 - 6	1,375	4,233	34,925	30,343	30,851	31,115
1 1/2 - 6	1,500	4,233	38,100	33,518	34,026	34,290
1 3/4 - 5	1,750	5,080	44,450	38,951	39,560	39,827
2 - 4 1/2	2,000	5,645	50,800	44,689	45,367	45,593
2 1/4 - 4 1/2	2,250	5,645	57,150	51,039	51,717	51,943
2 1/2 - 4	2,500	6,350	63,500	56,627	57,389	57,582
2 3/4 - 4	2,750	6,350	69,850	62,977	63,739	63,932
3 - 4	3,000	6,350	76,200	69,327	70,089	70,282
3 1/4 - 4	3,250	6,350	82,550	75,677	76,439	76,632
3 1/2 - 4	3,500	6,350	88,900	82,027	82,789	82,982
3 3/4 - 4	3,750	6,350	95,250	88,377	89,139	89,332
4 - 4	4,000	6,350	101,600	94,727	95,489	95,682

UNF

**ANSI
B 1.1**

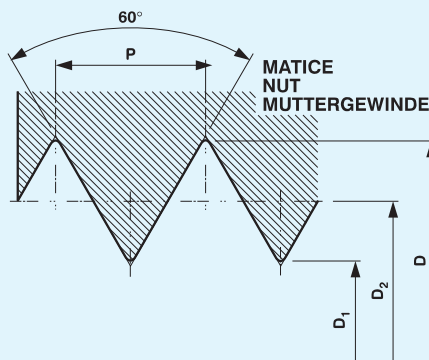

- D velký průměr závitu matice
major diameter of nut thread
Aussendurchmesser des Muttergewindes
- D_2 střední průměr závitu matice
pitch diameter of nut thread
Flankendurchmesser des Muttergewindes
- D_1 malý průměr závitu matice
minor diameter of nut thread
Kerndurchmesser des Muttergewindes
- P stoupání závitu
pitch of thread
Gewindesteigung
- N stoupání závitu v počtu závitů na 1"
pitch thread in threads per inch
Gewindesteigung in Gangzahl/1"

$d = D$

3B Přesné / Fine / Fein
2B Střední / Medium / Mittel
1B Hrubé / Coarse / Grob

Závit Thread / Gewinde		D_{min}	D_{1min}	D_{1max}	
d - N	d (")	P		3B, 2B, 1B	3B, 2B, 1B
0 - 80	0,060	0,318	1,524	1,181	1,306
1 - 72	0,073	0,353	1,854	1,473	1,613
2 - 64	0,086	0,397	2,184	1,755	1,913
3 - 56	0,099	0,454	2,515	2,024	2,197
4 - 48	0,112	0,529	2,845	2,271	2,459
5 - 44	0,125	0,577	3,175	2,550	2,741
6 - 40	0,138	0,635	3,505	2,817	3,012
8 - 36	0,164	0,706	4,166	3,401	3,597
10 - 32	0,190	0,794	4,826	3,967	4,168
12 - 28	0,216	0,907	5,486	4,503	4,717
1/4 - 28	0,250	0,907	6,350	5,367	5,588
5/16 - 24	0,313	1,058	7,938	6,792	6,995
3/8 - 24	0,375	1,058	9,525	8,379	8,565
7/16 - 20	0,438	1,270	11,112	9,738	9,947
1/2 - 20	0,500	1,270	12,700	11,326	11,524
9/16 - 18	0,563	1,411	14,288	12,761	12,969
5/8 - 18	0,625	1,411	15,875	14,348	14,554
3/4 - 16	0,750	1,588	19,050	17,330	17,546
7/8 - 14	0,875	1,814	22,225	20,262	20,493
1 - 12	1,000	2,117	25,400	23,109	23,363
1 1/8 - 12	1,125	2,117	28,575	26,284	26,538
1 1/4 - 12	1,250	2,117	31,750	29,459	29,713
1 3/8 - 12	1,375	2,117	34,925	32,634	32,888
1 1/2 - 12	1,500	2,117	38,100	35,809	36,063

Tr

DIN
103

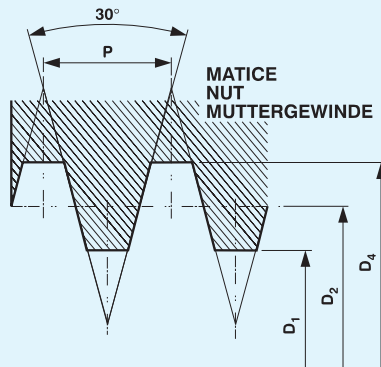

D_4 velký průměr závitu matice
major diameter of nut thread
Aussendurchmesser des Muttergewindes
 D_2 střední průměr závitu matice
pitch diameter of nut thread
Flankendurchmesser des Muttergewindes
 D_1 malý průměr závitu matice
minor diameter of nut thread
Kerndurchmesser des Muttergewindes
P stoupání závitu
pitch of thread
Gewindesteigung

$d = D$

7H Lícování střední
7H Tolerance medium
7H Toleranz mittel

Závít Thread / Gewinde			$D_{4 \min}$	$D_{2 \min}$	$D_{2 \max}$	$D_{1 \min}$	$D_{1 \max}$
\emptyset		P		7H	7H		
Tr 8	x	1,5	8,300	7,250	7,474	6,500	6,690
Tr 9	x	1,5	9,300	8,250	8,474	7,500	7,690
Tr 9	x	2	9,500	8,000	8,250	7,000	7,236
Tr 10	x	1,5	10,300	9,250	9,474	8,500	8,690
Tr 10	x	2	10,500	9,000	9,250	8,000	8,236
Tr 11	x	2	11,500	10,000	10,250	9,000	9,236
Tr 11	x	3	11,500	9,500	9,780	8,000	8,315
Tr 12	x	2	12,500	11,000	11,265	10,000	10,236
Tr 12	x	3	12,500	10,500	10,800	9,000	9,315
Tr 14	x	2	14,500	13,000	13,265	12,000	12,236
Tr 14	x	3	14,500	12,500	12,800	11,000	11,315
Tr 16	x	2	16,500	15,000	15,265	14,000	14,236
Tr 16	x	4	16,500	14,000	14,355	12,000	12,375
Tr 18	x	2	18,500	17,000	17,265	16,000	16,236
Tr 18	x	4	18,500	16,000	16,355	14,000	14,375
Tr 20	x	2	20,500	19,000	19,265	18,000	18,236
Tr 20	x	4	20,500	18,000	18,355	16,000	16,375
Tr 22	x	3	22,500	20,500	20,800	19,000	19,315
Tr 22	x	5	22,500	19,500	19,875	17,000	17,450
Tr 24	x	3	24,500	22,500	22,835	21,000	21,315
Tr 24	x	5	24,500	21,500	21,900	19,000	19,450
Tr 26	x	3	26,500	24,500	24,835	23,000	23,315
Tr 26	x	5	26,500	23,500	23,900	21,000	21,450
Tr 28	x	3	28,500	26,500	26,835	25,000	25,315
Tr 28	x	5	28,500	25,500	25,900	23,000	23,450
Tr 30	x	3	30,500	28,500	28,835	27,000	27,315
Tr 30	x	6	31,000	27,000	27,450	24,000	24,500
Tr 32	x	3	32,500	30,500	30,835	29,000	29,315
Tr 32	x	6	33,000	29,000	29,450	26,000	26,500
Tr 34	x	3	34,500	32,500	32,835	31,000	31,315
Tr 34	x	6	35,000	31,000	31,450	28,000	28,500
Tr 36	x	3	36,500	34,500	34,835	33,000	33,315
Tr 36	x	6	37,000	33,000	33,450	30,000	30,500
Tr 38	x	3	38,500	36,500	36,835	35,000	35,315
Tr 38	x	7	39,000	34,500	34,975	31,000	31,560
Tr 40	x	3	40,500	38,500	38,835	37,000	37,315
Tr 40	x	7	41,000	36,500	36,975	33,000	33,560
Tr 42	x	3	42,500	40,500	40,835	39,000	39,315
Tr 42	x	7	43,000	38,500	38,975	35,000	35,560
Tr 44	x	3	44,500	42,500	42,835	41,000	41,315
Tr 44	x	7	45,000	40,500	40,975	37,000	37,560
Tr 46	x	3	46,500	44,500	44,855	43,000	43,315
Tr 46	x	8	47,000	42,000	42,530	38,000	38,630
Tr 48	x	3	48,500	46,500	46,855	45,000	45,315
Tr 48	x	8	49,000	44,000	44,530	40,000	40,630
Tr 50	x	3	50,500	48,500	48,855	47,000	47,315
Tr 50	x	8	51,000	46,000	46,530	42,000	42,630
Tr 52	x	3	52,500	50,500	50,855	49,000	49,315
Tr 52	x	8	53,000	48,000	48,530	44,000	44,630
Tr 55	x	3	55,500	53,500	53,855	52,000	52,315
Tr 55	x	9	56,000	50,500	51,060	46,000	46,670
Tr 60	x	3	60,500	58,500	58,855	57,000	57,315
Tr 60	x	9	61,000	55,500	56,060	51,000	51,670

ZÁVITOVÉ TABULKY

Threading charts / Gewindetabellen

Rd

**DIN
405**

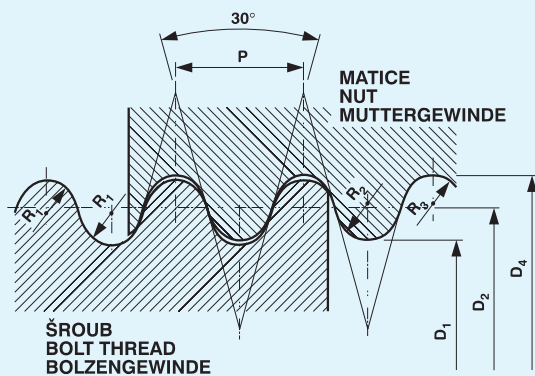

- D_4 velký průměr závitu matice
major diameter of nut thread
Aussendurchmesser des Muttergewindes
- D_2 střední průměr závitu matice
pitch diameter of nut thread
Flankendurchmesser des Muttergewindes
- D_1 malý průměr závitu matice
minor diameter of nut thread
Kerndurchmesser des Muttergewindes
- P stoupání závitu
pitch of thread
Gewindesteigung
- N stoupání závitu v počtu závitů na 1"
pitch thread in threads per inch
Gewindesteigung in Gangzahl/1"
- T_{D_1} Tolerance $\varnothing D_1$
Tolerance $\varnothing D_1$
Toleranz $\varnothing D_1$
- $d = D$

Závit Thread / Gewinde			$D_{4\min}$	D_1	R_1	R_2	R_3	T_{D_1}		
d	N	P						6H	7H	
8	10	2,540	8,254	5,714	0,606	0,650	0,561	0,450	0,560	
9	10	2,540	9,254	6,714	0,606	0,650	0,561	0,450	0,560	
10	10	2,540	10,254	7,714	0,606	0,650	0,561	0,450	0,560	
11	10	2,540	11,254	8,714	0,606	0,650	0,561	0,450	0,560	
12	10	2,540	12,254	9,714	0,606	0,650	0,561	0,450	0,560	
14	8	3,175	14,318	11,142	0,757	0,813	0,702	0,530	0,670	
16	8	3,175	16,318	13,142	0,757	0,813	0,702	0,530	0,670	
18	8	3,175	18,318	15,142	0,757	0,813	0,702	0,530	0,670	
20	8	3,175	20,318	17,142	0,757	0,813	0,702	0,530	0,670	
22	8	3,175	22,318	19,142	0,757	0,813	0,702	0,530	0,670	
24	8	3,175	24,318	21,142	0,757	0,813	0,702	0,530	0,670	
26	8	3,175	26,318	23,142	0,757	0,813	0,702	0,530	0,670	
28	8	3,175	28,318	25,142	0,757	0,813	0,702	0,530	0,670	
30	8	3,175	30,318	27,142	0,757	0,813	0,702	0,530	0,670	
32	8	3,175	32,318	29,142	0,757	0,813	0,702	0,530	0,670	
36	34	8	3,175	34,318	31,142	0,757	0,813	0,702	0,530	0,670
	38	8	3,175	36,318	33,142	0,757	0,813	0,702	0,530	0,670
40	42	6	4,233	40,423	36,190	1,010	1,084	0,936	0,630	0,800
	46	6	4,233	44,423	40,190	1,010	1,084	0,936	0,630	0,800
44	50	6	4,233	48,423	44,190	1,010	1,084	0,936	0,630	0,800
	58	6	4,233	52,423	48,190	1,010	1,084	0,936	0,630	0,800
48	62	6	4,233	56,423	52,190	1,010	1,084	0,936	0,630	0,800
	68	6	4,233	60,423	56,190	1,010	1,084	0,936	0,630	0,800
52	72	6	4,233	64,423	60,190	1,010	1,084	0,936	0,630	0,800
	78	6	4,233	68,423	64,190	1,010	1,084	0,936	0,630	0,800
55	82	6	4,233	72,423	68,190	1,010	1,084	0,936	0,630	0,800
	88	6	4,233	76,423	72,190	1,010	1,084	0,936	0,630	0,800
60	92	6	4,233	80,423	76,190	1,010	1,084	0,936	0,630	0,800
	98	6	4,233	84,423	80,190	1,010	1,084	0,936	0,630	0,800
65	102	6	4,233	88,423	84,190	1,010	1,084	0,936	0,630	0,800
	108	6	4,233	92,423	88,190	1,010	1,084	0,936	0,630	0,800
70	112	6	4,233	96,423	92,190	1,010	1,084	0,936	0,630	0,800
	118	6	4,233	100,423	96,190	1,010	1,084	0,936	0,630	0,800
75	122	6	4,233	104,423	100,190	1,010	1,084	0,936	0,630	0,800
	128	6	4,233	108,423	104,190	1,010	1,084	0,936	0,630	0,800
80	132	6	4,233	112,423	108,190	1,010	1,084	0,936	0,630	0,800
	138	6	4,233	116,423	112,190	1,010	1,084	0,936	0,630	0,800
85	142	6	4,233	120,423	116,190	1,010	1,084	0,936	0,630	0,800
	148	6	4,233	124,423	120,190	1,010	1,084	0,936	0,630	0,800
90	152	6	4,233	128,423	124,190	1,010	1,084	0,936	0,630	0,800
	158	6	4,233	132,423	128,190	1,010	1,084	0,936	0,630	0,800
95	162	6	4,233	136,423	132,190	1,010	1,084	0,936	0,630	0,800
	168	6	4,233	140,423	136,190	1,010	1,084	0,936	0,630	0,800
100	172	6	4,233	144,423	140,190	1,010	1,084	0,936	0,630	0,800
	178	6	4,233	148,423	144,190	1,010	1,084	0,936	0,630	0,800
110	182	4	6,350	154,635	146,285	1,515	1,625	1,404	0,850	1,060
	188	4	6,350	160,635	152,285	1,515	1,625	1,404	0,850	1,060
120	192	4	6,350	166,635	158,285	1,515	1,625	1,404	0,850	1,060
	198	4	6,350	172,635	164,285	1,515	1,625	1,404	0,850	1,060

ČTYŘHRANY PRO ZÁVITNÍKY

Squares for taps / Vierkantmass für Gewindebohrer

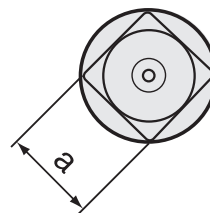
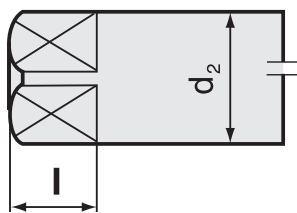

Podle normy DIN

Acc. DIN standard / Nach DIN Norm

ød ₂ mm	a mm	l mm
2,50	2,10	5
2,80	2,10	5
3,20	2,40	5
3,50	2,70	6
4,00	3,00	6
4,50	3,40	6
5,00	3,80	7
5,50	4,30	7
6,00	4,90	8
7,00	5,50	8
8,00	6,20	9
9,00	7,00	10
10,00	8,00	11
11,00	9,00	12
12,00	9,00	12
14,00	11,00	14
16,00	12,00	15
18,00	14,50	17
20,00	16,00	19
22,00	18,00	21
25,00	20,00	23
28,00	22,00	25
32,00	24,00	27

Podle normy ISO 529

Acc. ISO 529 standard / Nach ISO 529 Norm

ød ₂ mm	a mm	l mm
2,50	2,00	4
2,80	2,24	5
3,15	2,50	5
3,55	2,80	5
4,00	3,15	6
4,50	3,55	6
5,00	4,00	7
5,60	4,50	7
6,30	5,00	8
7,10	5,60	8
8,00	6,30	9
9,00	7,10	10
10,00	8,00	11
11,20	9,00	12
12,50	10,00	13
14,00	11,20	14
16,00	12,50	16
18,00	14,00	18
20,00	16,00	20
22,40	18,00	22
25,00	20,00	24
28,00	22,40	26
31,50	25,00	28

PŘEVOD PALCE - MILIMETRY

Conversion inches - millimetres / Umrechnung Zoll in Millimeter

Zlomek palce Inch fraction Zollbruch		Počet palců / Inch units / Zollen		
		0"	1"	2"
		Milimetry / Millimeters / Millimetern		
0	0,000	0,000	25,400	50,800
1/64	0,016	0,397	25,797	51,197
1/32	0,031	0,794	26,194	51,594
3/64	0,047	1,191	26,591	51,991
1/16	0,063	1,588	26,988	52,388
5/32	0,078	1,984	27,384	52,784
3/32	0,094	2,381	27,781	53,181
7/64	0,111	2,778	28,178	53,578
1/8	0,125	3,175	28,575	53,975
9/64	0,141	3,572	28,972	54,372
5/32	0,156	3,969	29,369	54,769
11/64	0,172	4,366	29,766	55,166
3/16	0,188	4,763	30,163	55,563
13/64	0,203	5,159	30,559	55,959
7/32	0,219	5,556	30,956	56,356
15/64	0,234	5,953	31,353	56,753
1/4	0,250	6,350	31,750	57,150
17/64	0,266	6,747	32,147	57,547
9/32	0,281	7,144	32,544	57,944
19/64	0,299	7,541	32,941	58,341
5/16	0,313	7,938	33,338	58,738
21/64	0,328	8,334	33,734	59,134
11/32	0,344	8,731	34,131	59,531
23/64	0,359	9,128	34,528	59,928
3/8	0,375	9,525	34,925	60,325
25/64	0,391	9,922	35,322	60,722
13/32	0,406	10,319	35,719	61,119
27/64	0,422	10,716	36,116	61,516
7/16	0,438	11,113	36,513	61,913
29/64	0,453	11,509	36,909	62,309
15/32	0,469	11,906	37,306	62,706
21/64	0,484	12,303	37,703	63,103

Zlomek palce Inch fraction Zollbruch		Počet palců / Inch units / Zollen		
		0"	1"	2"
		Milimetry / Millimeters / Millimetern		
1/2	0,500	12,700	38,100	63,500
33/64	0,516	13,097	38,497	63,897
17/32	0,531	13,494	38,894	64,294
35/64	0,547	13,891	39,291	64,691
9/16	0,563	14,288	39,688	65,088
37/64	0,578	14,684	40,084	65,484
19/32	0,594	15,081	40,481	65,881
39/64	0,609	15,478	40,878	66,278
5/8	0,625	15,875	41,275	66,675
41/64	0,641	16,272	41,672	67,072
21/32	0,656	16,669	42,069	67,469
43/64	0,672	17,066	42,466	67,866
11/16	0,688	17,463	42,863	68,263
45/64	0,703	17,859	43,259	68,659
23/32	0,719	18,256	43,656	69,056
47/64	0,734	18,653	44,053	69,453
3/4	0,750	19,050	44,450	69,850
49/64	0,766	19,447	44,847	70,247
25/32	0,781	19,844	45,244	70,644
51/64	0,797	20,241	45,641	71,041
13/16	0,813	20,638	46,038	71,438
53/64	0,828	21,034	46,434	71,834
27/32	0,844	21,431	46,831	72,231
55/64	0,859	21,828	47,228	72,628
7/8	0,875	22,225	47,625	73,025
57/64	0,891	22,622	48,022	73,422
29/32	0,906	23,019	48,419	73,819
59/64	0,922	23,416	48,816	74,216
15/16	0,938	23,813	49,213	74,613
61/64	0,953	24,209	49,609	75,009
31/32	0,969	24,606	50,006	75,406
63/64	0,984	25,003	50,403	75,803

PŘEVOD Vc - ot/min

Conversion chart / Umrechnungstabelle

		Řezná rychlost m/min / Cutting speed m/min. / Schnittgeschwindigkeit m/Min.																											
		1	2	3	4	5	6	7	8	9	10	12	14	15	16	18	20	22	24	25	26	28	30	32	34	35	40		
M	G	Otáčky/min. / Revolutions per minute / Drehzahl/Min.																											
2	UN	159	318	478	637	796	955	1115	1274	1433	1592	1911	2229	2389	2548	2866	3185	3503	3822	3981	4140	4459	4777	5096	5414	5573	6369		
2,5		127	255	382	510	637	764	892	1019	1146	1274	1529	1783	1911	2038	2293	2548	2803	3057	3185	3312	3567	3822	4076	4331	4459	5096		
3	No.5	106	212	318	425	531	637	743	849	955	1062	1274	1466	1592	1699	1911	2123	2335	2548	2654	2760	2972	3185	3397	3609	3715	4246		
4	No.8	80	159	239	318	398	478	557	637	717	796	955	1115	1194	1274	1433	1592	1752	1911	1990	2070	2229	2389	2548	2707	2787	3185		
5	No.10	64	127	191	255	318	382	446	510	573	637	764	892	955	1019	1146	1274	1401	1529	1592	1656	1783	1911	2038	2166	2229	2546		
6	1/4	53	106	159	212	265	318	372	425	478	531	637	743	796	849	955	1062	1168	1274	1327	1380	1486	1592	1699	1805	1858	2123		
7		45	91	136	182	227	273	318	364	409	455	546	637	682	728	819	910	1001	1092	1137	1183	1274	1365	1456	1547	1592	1820		
8	1/16"	40	80	119	159	199	239	279	318	358	398	478	557	597	637	717	796	876	955	995	1035	1115	1194	1274	1354	1393	1592		
9	3/8	35	71	106	142	177	212	248	283	318	354	425	495	531	566	637	708	778	849	885	920	991	1062	1132	1203	1238	1415		
10	1/8"	32	64	96	127	159	191	223	255	287	318	382	446	478	510	573	637	701	764	796	828	892	955	1019	1083	1115	1274		
12	1/4"	27	53	80	106	133	159	186	212	239	265	318	372	398	425	478	531	584	637	663	690	743	796	849	902	929	1062		
14		23	45	68	91	114	136	159	182	205	227	273	318	341	364	409	455	500	546	569	591	637	682	728	773	796	910		
16	3/8"	20	40	60	80	100	119	139	159	179	199	239	279	299	316	358	398	438	478	498	518	557	597	637	677	697	796		
18	3/4	18	35	53	71	88	106	124	142	159	177	212	248	265	283	318	354	389	425	442	460	495	531	566	602	619	708		
20	1/2"	16	32	48	64	80	96	111	127	143	159	191	223	239	255	287	318	350	382	398	414	446	478	510	541	557	637		
22	5/8"	14	29	43	58	72	87	101	116	130	145	174	203	217	232	261	290	318	347	362	376	405	434	463	492	507	579		
24	1	13	27	40	53	66	80	93	106	119	133	159	186	199	212	239	265	292	318	332	345	372	398	425	451	464	531		
27	3/4"	12	24	35	47	59	71	83	94	106	118	142	165	177	189	212	236	259	283	295	307	330	354	377	401	413	472		
30	7/8"	11	21	32	42	53	64	74	85	96	106	127	149	159	170	191	212	234	255	265	276	297	318	340	361	372	425		
33	1"	10	19	29	39	48	58	68	77	87	97	116	135	145	154	174	193	212	232	241	251	270	290	309	328	338	386		
36	1 3/8	9	18	27	35	44	53	62	71	80	88	106	124	133	142	159	177	195	212	221	230	248	265	283	301	310	354		
39	1 1/2	8	16	24	33	41	49	57	65	73	82	98	114	122	131	147	163	180	196	204	212	229	245	261	278	286	327		
42	1 1/4"	8	15	23	30	38	45	53	61	68	76	91	106	114	121	136	152	167	182	190	197	212	227	243	258	265	303		
45	1 3/8"	7	14	21	28	35	42	50	57	64	71	85	99	106	113	127	142	156	170	177	184	198	212	226	241	248	283		
48	1 1/2"	7	13	20	27	33	40	46	53	60	66	80	93	100	106	119	133	146	159	166	173	186	199	212	226	232	265		
52	2	6	12	18	24	31	37	43	49	55	61	73	86	92	98	110	122	135	147	153	159	171	184	196	208	214	245		

Rožměr nástroje / Diameter of tools / Werkzeugabmessung

MATERIÁLOVÉ EKVIVALENTY

Material equivalents / Materialäquivalent

ČSN	DIN	W. Nr.
10004	St 33	1.0035
11109	9 SMn 28	1.0715
11110	10 S 20	1.0721
11300	D6-2	1.0314
11320	St 22	1.0320
11364	HI	1.0345
11373	St 37-2	1.0037
11378	St 37-3	1.0116
11474	H IV	1.0445
11500	St 50-2	1.0050
11523	St 52-3	1.0570
11600	St 60-2	1.0060
11700	St 70-2	1.0070
12010	C 10	1.0305
12020	C 15	1.1141
12040	C 35	1.0501
12050	C 45	1.0503
12060	C 55	1.0535
12090	C 85 E	1.1269
13180	80 Mn 4	1.1259
13240	37 MnSi 5	1.5122
13250	46 Mn 7	1.0912
14100	100 Cr 6	1.3505
14109	100 Cr 6	1.3505
14220	16 MnCr 5	1.7131
14260	54 SiCr 6	1.7102
15142	42 CrMo 4	1.7225
15217	9 CrNiCuP 3-2-4	1.8962
15231	27 MnCrV 4	1.8162
15260	50 CrV 4	1.8159
15330	30 CrMoV 9	1.7707
15340	41 CrAlMo 7	1.8509
16220	15 CrNi 6	1.5919
16343	34 CrNiMo 6	1.6582
16420	14 NiCr 14	1.5752
16440	31 NiCr 14	1.5755
16523	14 NiCr 18	1.5860
17022	X 20 Cr 13	1.4021
17023	X 30 Cr 13	1.4028
17024	X 39 Cr 13	1.4031
17040	X 6 Cr 17	1.4016
17102	12 CrMo 19-5	1.7362
17153	X 8 CrTi 25	1.4746
17240	X 5 CrNi 18-10	1.4301
17241	X 10 CrNi 18-8	1.4310
17246	X 10 CrNiTi 18-10	1.4878
17247	X 6 CrNiTi 18-10	1.4541
17248	X 6 CrNiTi 18-10	1.4541
17251	X 15 CrNiSi 20-12	1.4828
17253	X 12 NiCrSi 36-16	1.4864
17255	X 8 CrNi 25-21	1.4845
17341	X 6 CrNiMo 17-13	1.4919
17346	X 5 CrNiMo 17-12-2	1.4401
17347	X 6 CrNiMoTi 17-12-2	1.4571
17350	X 2 CrNiMo 18-14-3	1.4435
17352	X 5 CrNiMo 17-13-3	1.4436
17353	X 10CrNiMoTi 18-12	1.4573
17359	X 2 CrNiMoN 17-11-2	1.4406
17360	X 2 CrNiMoN 17-13-3	1.4429
17381	X 2 CrNiMoN 22-5-3	1.4462
17436	X 40 MnCr 18	1.3817
17465	X 53CrMnNiN 21-9	1.4871
17618	X 120 Mn 12	1.3401
19191	C 105 W 1	1.1645
19192	C 105 W 2	1.1645
19255	C 125 W	1.1663
19312	90 MnCrV 8	1.2842
19314	100 MnCrW 4	1.2510
19356	100 V 1	1.2833
19436	X 210 Cr 12	1.2080
19452	62 SiMnCr 4	1.2101
19541	X 32 CrMoV 3-3	1.2365
19552	X 38 CrMoV 5-1	1.2343
19554	X 40 CrMoV 5-1	1.2344
19573	X 155 CrVMo 12-1	1.2379
19662	55 NiCrMoV 6	1.2711
19720	X 30 WCrV 5-3	1.2567
19721	X 30 WCrV 9-3	1.2581
19732	45 WCrV 7	1.2542
19733	60 WCrV 7	1.2550
19751	X 60 WCrMoV 9-4	1.2622
19824	S 18-0-1	1.3355
19829	S 6-5-2	1.3342

ČSN	DIN	W. Nr.
19830	S 6-5-2	1.3343
19852	S 6-5-2-5	1.3243
422304	GGG-40	0.7040
422305	GGG-50	0.7050
422306	GGG-60	0.7060
422307	GGG-70	0.7070
422308	GGG-80	0.7080
422410	GG-10	0.6010
422415	GG-15	0.6015
422420	GG-20	0.6020
422425	GG-25	0.6025
422430	GG-30	0.6030
422435	GG-35	0.6035
422533	GTS-35	0.8135
422536	GTW-35	0.8035
422540	GTW-40	0.8040
422545	GTS-45	0.8145
422555	GTS-55	0.8155
422630	GS-38	1.0416
422640	GS-45	1.0443
422650	GS-52	1.0552
422660	GS-60	1.0558
422709	GS-30 Mn 5	1.1165
422714	GS-20 Mn 5	1.1133
422744	G 17 CrMo 5-5	1.7357
422771	GX 15 CrMo 5	1.7365
422895	AlNiCo 44-5	
422905	X 12 Cr 13	1.4006
422920	GX 120 Mn 13	1.3802
422930	GX 5 CrNi 18-9	1.6901
422940	GX 6 CrNiMo 18-12	1.4437
422952	GX 40 CrNiSi 25-20	1.4848
423000	Cu 99,95	
423003	Cu 99,85	
423005	Cu 99,5	
423009	Cu 99,2 As	
423042	CuAl 5 As	2.0918
423047	CuAl 10 Ni 5 Fe 4	2.0966
423054	CuNi 2 Si	
423184	CuPb 30	
423200	CuZn 5	2.0220
423202	CuZn 15	2.0240
423203	CuZn 20	2.0250
423210	CuZn 30	2.0265
423213	CuZn 37	2.0321
423220	CuZn 40	2.0360
423222	CuZn 39 Pb 1	2.0380
423223	CuZn 40 Pb 2	2.0410
423560	ZnAl 4 Cu 1	2.2143
423562	ZnAlCu 3	2.2144
424002	Al 99,8	3.0285
424003	Al 99,7	3.0275
424005	Al 99,5	3.0255
424201	AlCuMg 1	3.1325
424222	AlZnMgCu 1,5	3.4365
424331	G-AlSi 11	3.2211
424332	G-AlSi 7 Mg	3.2371
424336	G-AlSi 12	3.2581
424338	GD-AlSi 8 Cu 3	3.2162
424339	G-AlSi 9 Cu 3	3.2163
424381	G-AlSi 5 Cu 1 Mg	3.2134
424384	G-AlSi 10 Mg	3.2381
424400	AlMgSi 1	3.2315
424412	AlMg 1	3.3315
424413	AlMg 3 Mn	3.3535
424415	AlMg 4 Mn	3.3545
424432	AlMn 1	3.0515
444357	G-AlSi 6 Cu 4	3.2151
HARDOX 400		
Inconel 718	NiCr 19 Fe 19 NbMo	2.4668

KONZULTAČNÍ DOTAZNÍK

Firma / Adresa:

Kontaktní osoba:

.....

.....

.....

Tel.: Fax:

.....

E-mail:

ZÁVIT

Druh závitu: M UN G W jiný

Rozměr:

Lícování:

Pravý závit: Levý závit:

CHARAKTER OTVORU (doplňte hodnoty)

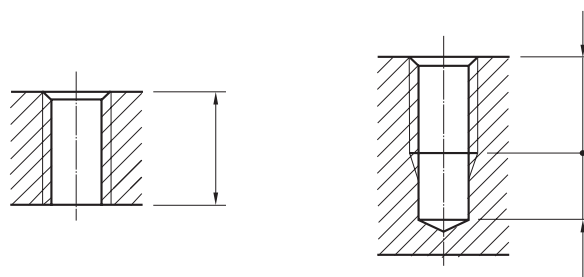

SOUČÁST / MATERIÁL

Označení materiálu:

Číslo materiálu:

Tvrdost / Pevnost:

Tříska: Dlouhá Střední Krátká

ŘEZNÉ PODMÍNKY

Řezná rychlost / otáčky:

Chlazení, mazání: emulze řezný olej

Stroj:

Způsob upnutí nástroje: Horizontální Vertikální

CHARAKTER VÝROBY

kusová sériová hromadná

DOSUD UŽÍVANÝ NÁSTROJ

.....

DALŠÍ ÚDAJE

.....

.....

.....

.....

.....

NAREX Ždánice, spol. s r.o. telefon: 518 607 111
Městečko 250 telefax: 518 607 154
696 32 Ždánice e-mail: sales@narexzd.cz

TECHNICAL SUPPORT QUESTIONNAIRE

Company / Address:

Contacting person:

.....

.....

.....

Phone: Fax:

.....

E-mail:

THREAD

Thread type: M UN G W other

Dimension:

Tolerance:

Right thread: Left thread:

HOLE (fill in the dimensions)

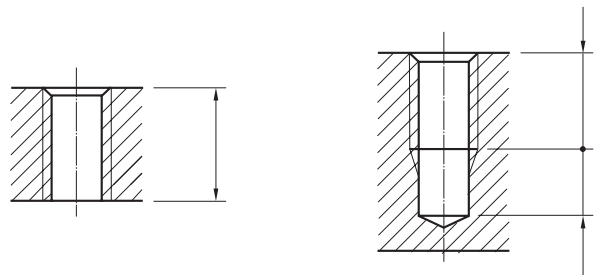

WORKPIECE / MATERIAL

Type of material:

No. or classification:

Hardness / Strength:

Chip type: Long Medium Short

CUTTING CONDITIONS

Cutting speed / rpm:

Cooling, lubrication: Emulsion Cutting oil

Machine:

Tap clamping: Horizontal Vertical

PRODUCTION CHARACTERISTIC

Piece production Series production Mass production

TAP USED IN THE PAST

.....

ADDITIONAL INFORMATION

.....

.....

.....

.....

NAREX Ždánice, spol. s r.o. phone: +420 518 607 111
 Městečko 250 telefax: +420 518 607 155
 CZ - 696 32 Ždánice e-mail: sales@narexzd.cz

FRAGEBOGEN FÜR GEWINDEBOHRERANGEBOT

Firma / Adresse:

Kontaktperson:

.....

.....

.....

Tel.: Fax:

.....

E-mail:

GEWINDE

Gewindeart: M UN G W andere

Abmessung:

Toleranz:

Rechtsgewinde: Linksgewinde:

LOCHTYP (geben Sie bitte Tiefen an)

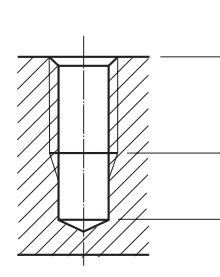
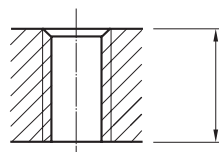

WERKSTÜCK / WERKSTOFF

Werkstoffbezeichnung:

Werkstoffnummer:

Härte / Festigkeit:

Spanform: Lang Mittel Kurze

ARBEITSBEDINGUNGEN

Schnittgeschwindigkeit / Drehzahl:

Kühlungsmittel: Emulsion Schneidöl

Maschine:

Arbeitsbedingungen Werkzeugaufnahme: Horizontal Vertikal

FERTIGUNGSART

Sonderfertigung Serienproduktion Massenproduktion

ZUR ZEIT VERWENDETES WERKZEUG

.....

SONSTIGES

.....

.....

.....

.....

.....

NAREX Žďanice, spol. s r.o. telefon: +420 518 607 111
Městečko 250 telefax: +420 518 607 155
CZ - 696 32 Žďanice e-mail: sales@narexzd.cz

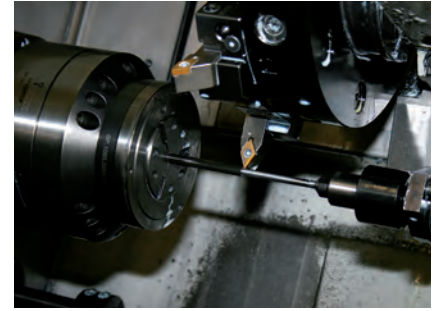

Soustružení polotovaru
Form turning
Rohlingendrehen



Kalení polotovaru
Heat treatment
Rohlingenhärten

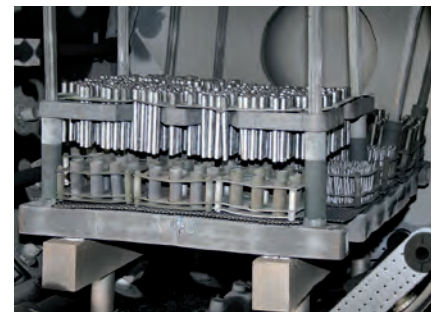

Broušení tvaru
Form grinding
Profilschleifen



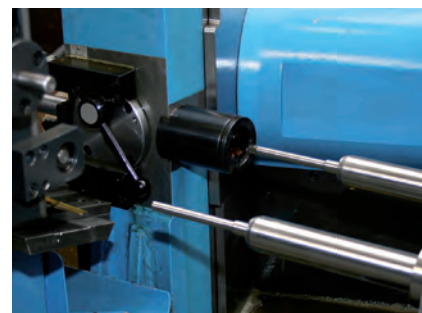

Broušení čtyřhranu
Square grinding
Vierkantschleifen

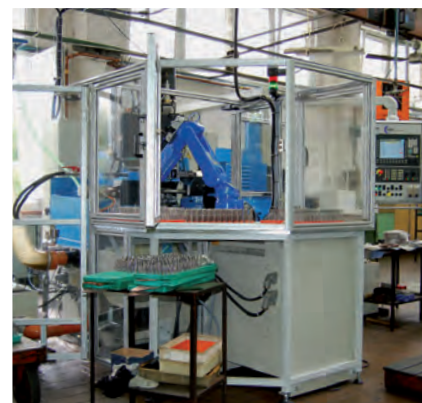

Broušení drážek
Flute grinding
Nutenschleifen

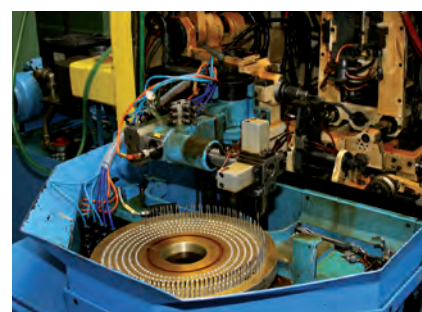



Broušení závitu
Thread grinding
Gewindeschleifen

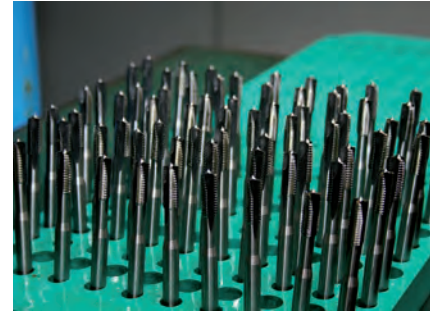
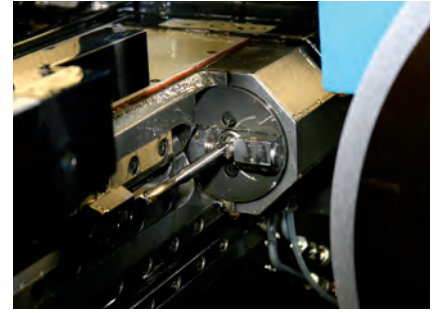

Označování barevnými kroužky
Colour ring marking
Farbringmarkierung

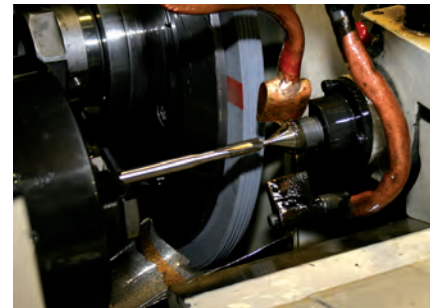

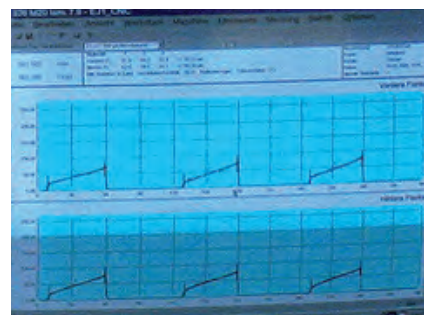

Měření a zkoušení
Measurement and testing
Messung und Prüfung



Kat. č. / Cat. No. / Kat. Nr.	Závit / Thread / Gewinde	Strana / Page
0200	M	70
0204	UNC	75
0290	M	71
0300	MF	72
0302	G	74
0305	UNF	76
0550	M	67
0600	M	67
0650	M	67
1000	M	30
1000 EG	EG-M	77
1004	UNC	62
1010	M	30
1014	UNC	62
1080	M	46
1080 IKZ	M	46
1130	M	46
1130 IKZ	M	46
1500	M	32
1504	UNC	62
1510	M	32
1514	UNC	62
1540	M	32
1570	M	45
1580	M	42
1590	M	42
1620	M	45
1660	M	38
1690	M	38
1710	M	48
1750	M	32
1870	M	38
1870	M	38
1920	M	44
2050	M	34
2054	UNC	64
2060	M	34
2064	UNC	64
2090	M	34
2210	M	48
2260	M	40
2290	M	40
2320	M	40
2320 IKZ	M	40
2360	M	36
2390	M	36
2400	M	36
2410	M	36
2670	M	45
2680	M	42
2690	M	42
2720	M	45
2820	M	44
2870	M	44
2910	M	68
2960	M	68
3000	M	31
3000	MF	49
3000 EG	EG-M	77
3002	G	59
3004	UNC	63
3005	UNF	65
3010	M	31
3010	MF	49
3012	G	59
3014	UNC	63
3015	UNF	65
3080	M	47
3080	MF	57
3080 IKZ	M	47
3080 IKZ	MF	57
3130	M	47
3130	MF	57
3130 IKZ	M	47
3130 IKZ	MF	57
3500	M	33
3500	MF	49
3502	G	59
3504	UNC	63
3505	UNF	65
3510	M	33
3510	MF	49
3512	G	59

Kat. č. / Cat. No. / Kat. Nr.	Závit / Thread / Gewinde	Strana / Page
3514	UNC	63
3515	UNF	65
3540	M	33
3540	MF	49
3570	M	45
3580	M	43
3580	MF	55
3590	M	43
3590	MF	55
3620	M	45
3660	M	39
3660	MF	53
3662	G	61
3690	M	39
3690	MF	53
3692	G	61
3710	M	48
3870	M	39
3870 IKZN	M	39
3920	M	44
4050	M	35
4050	MF	51
4052	G	60
4054	UNC	64
4055	UNF	66
4060	M	35
4060	MF	51
4062	G	60
4064	UNC	64
4065	UNF	66
4090	M	35
4090	MF	51
4210	M	48
4260	M	41
4260	MF	53
4262	G	61
4290	M	41
4290	MF	53
4292	G	61
4320	M	41
4320 IKZ	M	41
4360	M	37
4390	M	37
4400	M	37
4410	M	37
4670	M	45
4680	M	43
4680	MF	55
4690	M	43
4690	MF	55
4720	M	45
4820	M	44
4870	M	44
5000	M	69
5706	Tr	77
9500	M	82
9500	MF	83
9501	W	87
9502	G	84
9504	UNC	85
9505	UNF	86
9550	M	82
9550	MF	83
9552	G	84
9900	M	79
9910	M	79
9920	M	79
9930	M	80
9940	M	80
9950	M	80
9960	M	81